

Trademarks

Autel[®], MaxiSys[®], MaxiDAS[®], MaxiScan[®], MaxiTPMS[®], MaxiRecorder[®], and MaxiCheck[®] are trademarks of Autel Intelligent Technology Corp., Ltd., registered in China, the United States and other countries. All other marks are trademarks or registered trademarks of their respective holders.

Copyright Information

No part of this manual may be reproduced, stored in a retrieval system or transmitted, in any form or by any means, electronic, mechanical, photocopying, recording, or otherwise without the prior written permission of Autel.

Disclaimer of Warranties and Limitation of Liabilities

All information, specifications and illustrations in this manual are based on the latest information available at the time of printing.

Autel reserves the right to make changes at any time without notice. While information of this manual has been carefully checked for accuracy, no guarantee is given for the completeness and correctness of the contents, including but not limited to the product specifications, functions, and illustrations.

Autel will not be liable for any direct, special, incidental, indirect damages or any economic consequential damages (including the loss of profits).

IMPORTANT

Before operating or maintaining this unit, please read this manual carefully, paying extra attention to the safety warnings and precautions.

For Services and Support

 pro.autel.com
 www.autel.com

 1-855-288-3587/1-855-AUTELUS (North America)
0086-755-86147779 (China)

 Support@autel.com

For technical assistance in all other markets, please contact your local selling agent.

Safety Information

For your own safety and the safety of others, and to prevent damage to the device and vehicles upon which it is used, it is important that the safety instructions presented throughout this manual be read and understood by all persons operating or coming into contact with the device.

There are various procedures, techniques, tools, and parts for servicing vehicles, as well as in the skill of the person doing the work. Because of the vast number of test applications and variations in the products that can be tested with this equipment, we cannot possibly anticipate or provide advice or safety messages to cover every circumstance. It is the automotive technician's responsibility to be knowledgeable of the system being tested. It is crucial to use proper service methods and test procedures. It is essential to perform tests in an appropriate and acceptable manner that does not endanger your safety, the safety of others in the work area, the device being used, or the vehicle being tested.

Before using the device, always refer to and follow the safety messages and applicable test procedures provided by the manufacturer of the vehicle or equipment being tested. Use the device only as described in this manual. Read, understand, and follow all safety messages and instructions in this manual.

Safety Messages

Safety messages are provided to help prevent personal injury and equipment damage. All safety messages are introduced by a signal word indicating the hazard level.

DANGER

Indicates an imminently hazardous situation which, if not avoided, will result in death or serious injury to the operator or to bystanders.

WARNING

Indicates a potentially hazardous situation which, if not avoided, could result in death or serious injury to the operator or to bystanders.

Safety Instructions

The safety messages herein cover situations Autel is aware of. Autel cannot know, evaluate or advise you as to all of the possible hazards. You must be certain that any condition or service procedure encountered does not jeopardize your personal safety.

DANGER

When an engine is operating, keep the service area WELL VENTILATED or attach a building exhaust removal system to the engine exhaust system. Engines produce carbon monoxide, an odorless, poisonous gas that causes slower reaction time and can lead to serious personal injury or loss of life.

SAFETY WARNINGS

- Always perform automotive testing in a safe environment.
- Wear safety eye protection that meets ANSI standards.
- Keep clothing, hair, hands, tools, test equipment, etc. away from all moving or hot engine parts.
- Operate the vehicle in a well ventilated work area, for exhaust gases are poisonous.
- Put the transmission in PARK (for automatic transmission) or NEUTRAL (for manual transmission) and make sure the parking brake is engaged.
- Put blocks in front of the drive wheels and never leave the vehicle unattended while testing.
- Be extra cautious when working around the ignition coil, distributor cap, ignition wires and spark plugs. These components create hazardous voltages when the engine is running.
- Keep a fire extinguisher suitable for gasoline, chemical, and electrical fires nearby.
- Do not connect or disconnect any test equipment while the ignition is on or the engine is running.
- Keep the test equipment dry, clean, free from oil, water or grease. Use a mild detergent on a clean cloth to clean the outside of the equipment as necessary.
- Do not drive the vehicle and operate the test equipment at the same time. Any distraction may cause an accident.

- Refer to the service manual for the vehicle being serviced and adhere to all diagnostic procedures and precautions. Failure to do so may result in personal injury or damage to the test equipment.
- To avoid damaging the test equipment or generating false data, make sure the vehicle battery is fully charged and the connection to the vehicle DLC is clean and secure.
- Do not place the test equipment on the distributor of the vehicle. Strong electro-magnetic interference can damage the equipment.

CONTENTS

1	USING THIS MANUAL	1
	CONVENTIONS	1
2	GENERAL INTRODUCTION	3
	MAXICOM DISPLAY TABLET	3
	ACCESSORY KIT	7
3	GETTING STARTED	9
	POWERING UP	9
	POWERING DOWN.....	13
4	DIAGNOSTICS OPERATIONS.....	14
	GETTING STARTED	14
	VEHICLE IDENTIFICATION	15
	NAVIGATION	20
	DIAGNOSIS.....	23
	GENERIC OBD II OPERATIONS.....	35
	EXITING DIAGNOSTICS.....	39
5	SERVICE OPERATIONS.....	41
	OIL RESET SERVICE	41
	ELECTRONIC PARKING BRAKE (EPB) SERVICE	44
	BMS.....	48
	STEERING ANGLE SENSOR (SAS) SERVICE	51
	DPF SERVICE	56
	TIRE PRESSURE MONITOR SYSTEM (TPMS) SERVICE	61
	IMMO SERVICE	64
6	SHOP MANAGER OPERATIONS	66
	VEHICLE HISTORY.....	67
	WORKSHOP INFORMATION	69
	CUSTOMER MANAGER.....	70
7	DATA MANAGER OPERATIONS.....	74
	OPERATIONS.....	74

8	SETTINGS OPERATIONS	80
	UNIT.....	80
	LANGUAGE.....	81
	PRINTING SETTING.....	82
	NOTIFICATION CENTER.....	83
	AUTO UPDATE.....	84
	ABOUT.....	85
	SYSTEM SETTINGS.....	86
	FIRMWARE.....	86
9	UPDATE OPERATIONS.....	88
10	SUPPORT OPERATIONS.....	91
	PRODUCT REGISTRATION	91
	SUPPORT SCREEN LAYOUT.....	92
	MY ACCOUNT.....	92
	USER COMPLAINT.....	93
	DATA LOGGING.....	96
	COMMUNITIES	96
	USER PROFILE	98
	TRAINING CHANNELS	98
	FAQ DATABASE	99
11	ACADEMY OPERATIONS	100
12	REMOTE DESK OPERATIONS.....	101
13	MAXIFIX OPERATIONS.....	103
	NAVIGATION.....	103
	OPERATIONS.....	106
14	QUICK LINK OPERATIONS.....	112
15	FUNCTION VIEWER OPERATIONS	113
16	MAINTENANCE AND SERVICE	116
	MAINTENANCE INSTRUCTIONS	116
	TROUBLESHOOTING CHECKLIST	117
	ABOUT BATTERY USAGE	117

SERVICE PROCEDURES	118
17 COMPLIANCE INFORMATION.....	122
18 WARRANTY	125
LIMITED ONE YEAR WARRANTY.....	125

1 Using this Manual

This manual contains device usage instructions.

Some illustrations shown in this manual may contain modules and optional equipment that are not included in your system.

Conventions

The following conventions are used.

Bold Text

Bold text is used to highlight selectable items such as buttons and menu options.

Example:

- Tap **OK**.

Notes and Important Messages

Notes

A **NOTE** provides helpful information such as additional explanations, tips, and comments.

Example:



NOTE

New batteries reach full capacity after approximately 3 to 5 charging and discharging cycles.

Important

IMPORTANT indicates a situation which, if not avoided, may result in damage to the tablet or vehicle.

Example:

! **IMPORTANT**

Keep the cable away from heat, oil, sharp edges and moving parts. Replace damaged cables immediately.

Hyperlink

Hyperlinks, or links, that take you to other related articles, procedures, and illustrations are available in electronic documents. Blue italic text indicates a selectable hyperlink and blue underlined text indicates a website link or an email address link.

Illustrations

Illustrations used in this manual are samples, the actual testing screen may vary for each vehicle being tested. Observe the menu titles and on-screen instructions to make correct option selection.

2 General Introduction

When it comes to ultra-portability, MaxiCOM MK808 is your perfect companion. Installed with a fast quad-core processor, MK808 offers maximum convenience and swift diagnosis. The intuitive user screen makes using the device effortless through a 7-inch LCD touchscreen that displays at 1024 x 600 quality. Together with the ability to quickly read and clear DTCs for all available modules of the majority of the makes and models on the market, MK808 provides you with superior special functions, including Oil Reset, EPB (Electronic Parking Brake), SAS (Steering Angle Sensor), BMS (Battery Management System), DPF (Diesel Particulate Filter), IMMO, and TPMS (Tire Pressure Monitoring System).

This manual describes the construction and operation of the device and how it works to deliver diagnostic solutions.

MaxiCOM MK808 Display Tablet

Functional Description

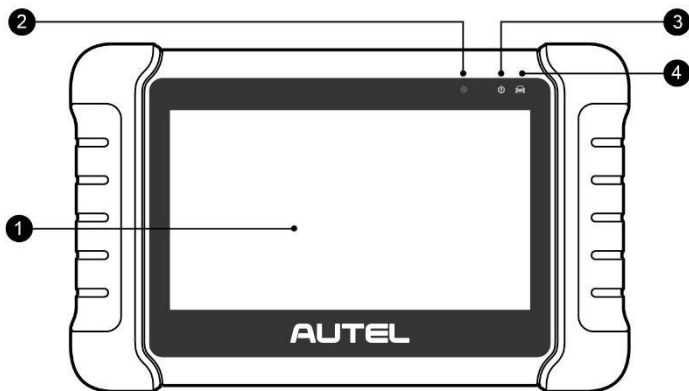

Figure 2-1 Display Tablet Front View

1. 7.0" LCD Capacitive Touchscreen
2. Ambient Light Sensor – detects ambient brightness.

3. Power LED – indicates battery level & charging or system status.
4. Vehicle Communication LED – flashes green when the Display Tablet is communicating/linking with the vehicle's system.

The power LED displays green, yellow or red depending on power level and operating state.

A. Green

- Illuminates green when the Display Tablet is charging and the battery level is above 90%.
- Illuminates green when the Display Tablet is powered on and the battery level is above 15%.

B. Yellow

- Illuminates yellow when the Display Tablet is charging and the battery level is below 90%.

C. Red

- Illuminates red when the Display Tablet is powered on and the battery level is below 15%.

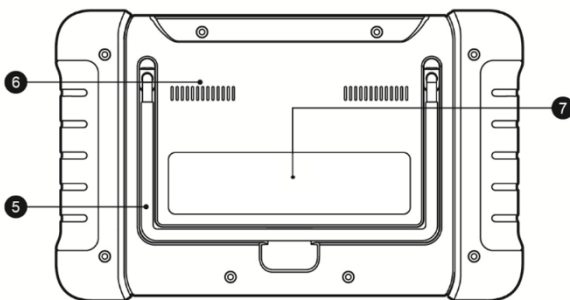

Figure 2-2 MaxiCOM MK808 Display Tablet Back View

5. Collapsible Stand – extends from the back to allow hands-free viewing of the Display Tablet.
6. Heat Sink
7. Built-in Battery

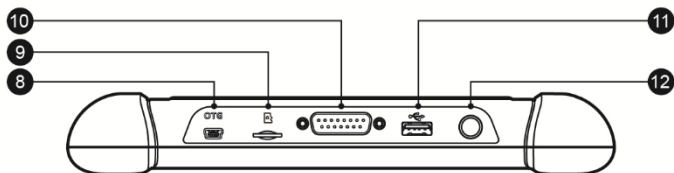

Figure 2-3 MaxiCOM MK808 Display Tablet Top View

8. Mini USB OTG Port
9. Micro SD Card Slot – holds the micro SD card.
10. DB15-Pin Port – connects the main cable.
11. USB Port
12. Lock/Power Button – long press button to turn tablet off and on. Quick press button to lock screen.

Power Sources

The Display Tablet can receive power from any of the following sources:

- Internal Battery Pack
- Vehicle Power
- External Power Supply

Internal Battery Pack

The Display Tablet can be powered with the internal rechargeable battery, which if fully charged can provide sufficient power for about 4.5 hours of continuous operation.

Vehicle Power

When the Display Tablet is connected to the test vehicle via the main cable, the Display Tablet automatically receives power from the vehicle.

External Power Supply

The Display Tablet can be powered from a wall socket using the mini USB cable and USB external power adapter. The external power supply also charges the internal battery pack.

Technical Specifications

Table 2-1 Specifications

Item	Description
Recommended Use	Indoor
Operating System	Android™ 4.4.4
Processor	Cortex-A9 processor (1.5 GHz)
Memory	64GB
Display	7-inch LCD capacitive touchscreen with 1024x600 resolution
Connectivity	<ul style="list-style-type: none">• Mini USB 2.0• USB 2.0• Wi-Fi• Micro SD card (supports up to 32GB)
Sensors	Ambient light sensor for brightness auto adjust
Audio Input/Output	<ul style="list-style-type: none">• Input: N/A• Output: Beep
Power and Battery	<ul style="list-style-type: none">• 3.7 V/3200 mAh lithium-polymer battery• Charges via 5 VDC power supply
Tested Battery Life	Around 4.5 hours of continuous use
Battery Charging Input	5 V/1.5 A
Power Consumption	500 mA (LCD on with default brightness, Wi-Fi on) @3.7 V
Operating Temp.	0 to 50°C(32 to 122°F)
Storage Temp.	-10 to 60°C (14 to 140°F)
Operating Humidity	5% - 95% non-condensing

Item	Description
Dimensions (W x H x D)	237.8 mm (9.4") x 148.6 mm (5.9") x 35.5 mm (1.4")
Net Weight	788 g (2.42 lb.)
Supported Automotive Protocols	ISO9141-2, ISO14230-2, ISO15765, K/L-Line, Flashing Code, SAE-J1850 VPW, SAE-J1850 PWM, ISO11898(Highspeed, Middlespeed, Lowspeed and Singlewire CAN, fault-tolerant CAN), SAE J2610, GM UART, UART Echo Byte Protocol, Honda Diag-H Protocol, TP2.0, TP1.6

Accessory Kit

Main Cable

The Main Cable connects the Display Tablet to the vehicle's data link connector (DLC).

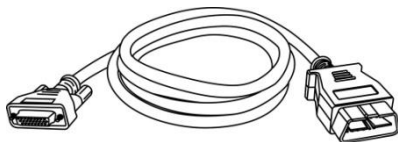

Figure 2-4 Main Cable

Other Accessories



Mini USB Cable

Connects the Display Tablet to the PC or DC external power adapter.

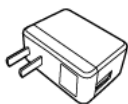

USB External Power Adapter

Together with the mini USB cable, connects the Display Tablet to the external DC power port for power supply.

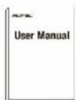

User Manual

Tool operations instructions.



Quick Guide

Device connection and diagnostic software update instructions.

3 Getting Started

Ensure the tablet is sufficiently charged or is connected to the external power supply (see [Power Sources](#) on page 5).

NOTE

The images and illustrations depicted in this manual may differ from the actual ones.

Powering Up

Press the Lock/Power button on the top right side of the tablet to power the unit on. The system boots up, and displays the lock screen. Slide the Lock icon to the left to access the MaxiCOM Job Menu or slide to the right to unlock.

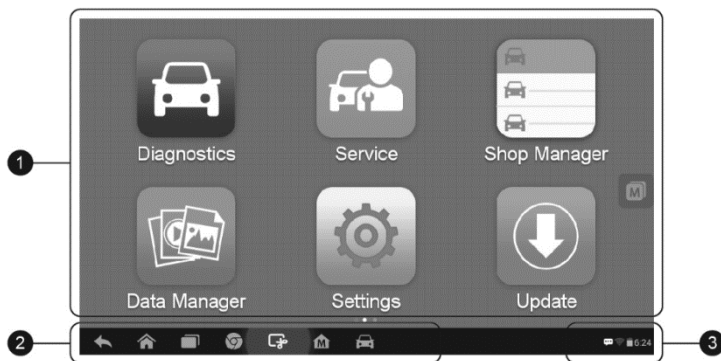

Figure 3-1 Sample MaxiCOM MK808 Job Menu

1. Application Buttons
2. Locator and Navigation Buttons
3. Status Icons

NOTE







The tablet screen is locked by default upon startup. It is recommended to lock the screen when not in use to protect the information in the system and conserve the power.







Almost all operations on the tablet are controlled through the touchscreen. The touchscreen navigation is menu driven, which allows you to quickly locate the test procedure, or data that you need, through a series of choices and questions. Detailed descriptions of the menu structures are found in the chapters for each application.

Application Buttons

The tablet below briefly describes each of the applications in the MaxiCOM system.

Table 3-1 Applications









Button	Name	Description
	Diagnostics	Accesses diagnostic functions menu. See Diagnostics Operations on page 14.
	Service	Accesses special functions menu. See Service Operations on page 41.
	Shop Manager	Edits and saves workshop information and customer data, as well as reviewing test vehicle history records. See Shop Manager Operations on page 66.
	Data Manager	Accesses the organization system for saved data files. See Data Manager Operations on page 74.
	Settings	Accesses MaxiCOM system settings menu and general tablet menu. See Settings Operations on page 80.
	Update	Checks for the latest update available for the MaxiCOM system, and performs updates. See Update Operations on page 89.

Button	Name	Description
	Support	Launches the Support platform which synchronizes Autel's on-line service base station with the MaxiCOM tablet. See Support Operations on page 91.
	Academy	Accesses technical tutorials and training articles about the device usage and vehicle diagnostic techniques. See Academy Operations on page 100 for details.
	Remote Desk	Configures the unit to receive remote support using the TeamViewer application program. See Remote Desk Operations on page 101.
	MaxiFix	Launches the MaxiFix platform which provides the most compatible and abundant repair techniques and diagnostics database. See MaxiFix Operations on page 103.
	Quick Link	Provides associated website bookmarks to allow quick access to product update, service, support and other information. See Quick Link Operations on page 112.
	Function Viewer	Provides quick search for the supported functions and vehicles of Autel diagnostic tools. See Function Viewer Operations on page 113.

Locator and Navigation Buttons

Operations of the Navigation buttons at the bottom of the screen are described in the table below:

Table 3-2 Locator and Navigation Buttons

Button	Name	Description
	Locator	Indicates the location of the screen. Swipe the screen left or right to view the previous or next screen.
	Back	Returns to the previous screen.
	Android Home	Returns to Android System's Home screen.
	Recent Apps	Displays a list of applications that are currently in use. Tap an app icon to launch. To remove an app, swipe it to the top or bottom.
	Chrome	Launches the Android built-in browser.
	Screenshot	Takes a screenshot when you want to save the displayed information.
	MaxiCOM Home	Returns to MaxiCOM Job Menu.
	Diagnostic Shortcut	Returns to the Diagnostic screen.
	Service Shortcut	Returns to the Service screen.





System Status Icons

Tap on the bottom right corner to display Shortcuts Panel to set system settings of the tablet. Each icons function is described in the table below:

NOTE

The shortcuts buttons will be highlighted when enabled and dimmed when disabled.

Table 3-3 Shortcuts Panel Buttons

Button	Name	Description
	Calculator	Launches calculator when pressed.
	Clock	Launches clock when pressed.
	Wi-Fi	Enables/disables Wi-Fi when pressed.
	Airplane Mode	Enables/disables Airplane Mode when pressed.
	System Settings	Launches the Android System Settings screen when pressed.

Powering Down

All vehicle communications must be terminated before shutting down the Display Tablet. A warning message displays if a shutdown is attempted while the tablet is communicating with the vehicle. Forcing a shutdown while the tablet is communicating may lead to ECM problems on some vehicles. Please exit the Diagnostics application before shutting off the tablet.

➤ **To power down the display tablet**

1. Long press the Lock/Power Button.
2. Tap **Power off** option.
3. Tap **OK**, the tablet will turn off in a few seconds.

Reboot System

In case of system crash, long press the Lock/Power button and tap **Reboot** option to restart the system.

4 Diagnostics

The Diagnostics application can access the electronic control unit (ECU) of various vehicle control systems, such as engine, transmission, antilock brake system (ABS), airbag system (SRS) and more.

Getting Started

The Diagnostics operations require connecting the MaxiCOM MK808 to the test vehicle's DLC using the main cable.

Vehicle Menu Layout

When the tablet is properly connected to the vehicle, the platform is ready to start vehicle diagnosis. Tap on the **Diagnostics** application button on the MaxiCOM MK808 Job Menu, the Vehicle Menu then displays.











Figure 4-1 Sample Vehicle Menu

1. Top Toolbar Buttons
2. Manufacturer Buttons

Top Toolbar Buttons

The operations of the toolbar buttons at the top of the screen are listed and described in the table below:

Table 4-1 Top Toolbar Buttons

Button	Name	Description
	Home	Returns to the MaxiCOM Job Menu.
	VIN Scan	Displays a dropdown list; tap Auto Detect for auto VIN detection; tap Manual Input to enter VIN manually.
	All	Displays a menu of vehicle manufacturers.
	History	Displays stored test vehicle history records. Tap record to review record in detail. See Vehicle History on page 68.
	USA	Displays the USA vehicle menu.
	Europe	Displays the European vehicle menu.
	Asia	Displays the Asian vehicle menu.
	Search	Searches for a specific vehicle make.
	Cancel	Tap to exit the search screen, or cancels an operation.

Manufacturer Buttons

The vehicle manufacturer buttons display the vehicle brands currently compatible with the tool. After establishing communication with the vehicle. Tap the desired manufacturer button to start a diagnostic session.

Vehicle Identification

The MaxiCOM diagnostic system supports four methods for Vehicle Identification.

1. Auto VIN Scan
2. Manual VIN Input
3. Automatic Selection
4. Manual Selection

Auto VIN Scan

The MaxiCOM diagnostic system features the latest VIN-based Auto VIN Scan function to identify vehicles with just one touch, enabling the technician to quickly identify the vehicle, scan all the diagnosable ECUs on the vehicle and perform diagnostics on the selected system.

➤ To perform Auto VIN Scan

1. Tap the **Diagnostics** application button from the MaxiCOM Job Menu. The Vehicle Menu displays.
2. Tap the **VIN Scan** button on the top toolbar to open a dropdown list.



Figure 4-2 Sample Auto VIN Screen 1

3. Select **Auto Detect**. Once the test vehicle is successfully identified, the screen will display the Vehicle Identification Number (VIN), tap **OK** at the bottom right to confirm. If the VIN does not match, enter the VIN manually or tap **Read** to acquire VIN again.

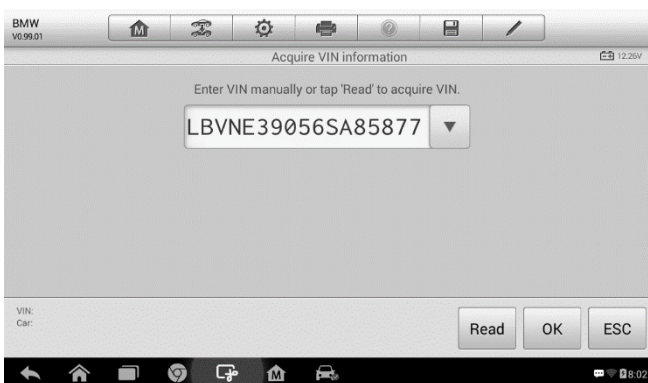

Figure 4-3 Sample Auto VIN Screen 2

4. Review the information to ensure it is correct. Tap **Yes** to confirm the vehicle or **NO** if the information is not correct.

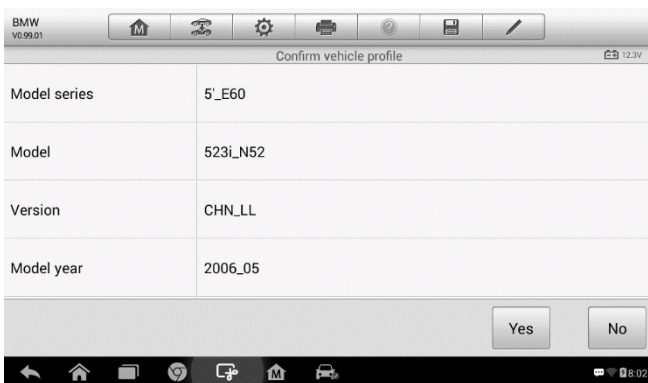

Figure 4-4 Sample Vehicle Profile Screen

5. The tool will establish communication with the vehicle to read control unit information. Choose **Auto Scan** to scan all the available systems of the test vehicle or tap **Control Unit** to access the system that you want to diagnose.

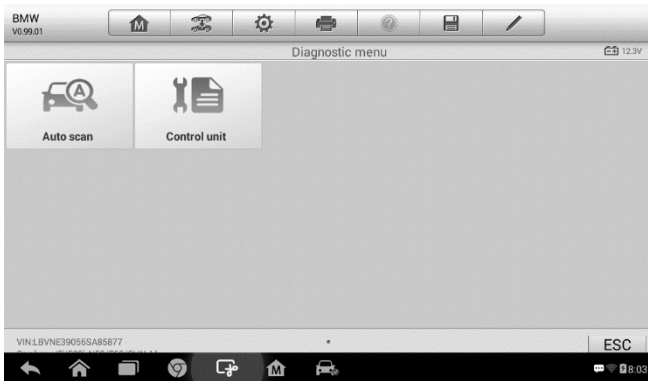

Figure 4-5 Sample Diagnostic Screen

Manual VIN Input

For some vehicles that not supporting the Auto VIN Scan function, the MaxiCOM diagnostic system allows you to enter the vehicle VIN manually.

➤ To perform Manual VIN Input

1. Tap the **Diagnostics** application button from the MaxiCOM Job Menu. The Vehicle Menu displays.
2. Tap the **VIN Scan** button on the top toolbar.
3. Select **Manual Input**.
4. Tap the input box and enter the correct VIN.

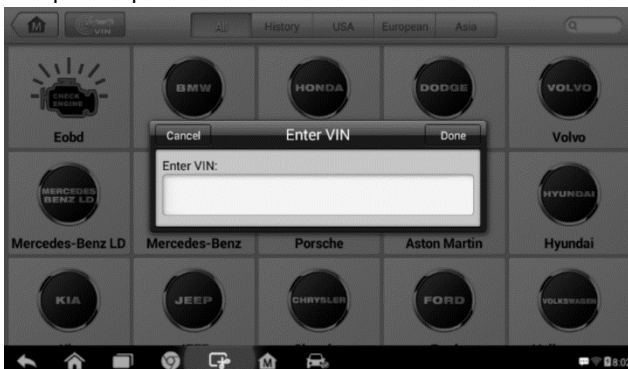

Figure 4-6 Sample Diagnostic Screen

5. Tap **Done**. The vehicle will be identified and the Vehicle Diagnostics screen will display.
6. Tap **Cancel** to exit Manual Input.

Automatic Selection

In some cases when users have selected the vehicle brand instead of performing Auto VIN Scan, the system will still provide an option for vehicle VIN scan.

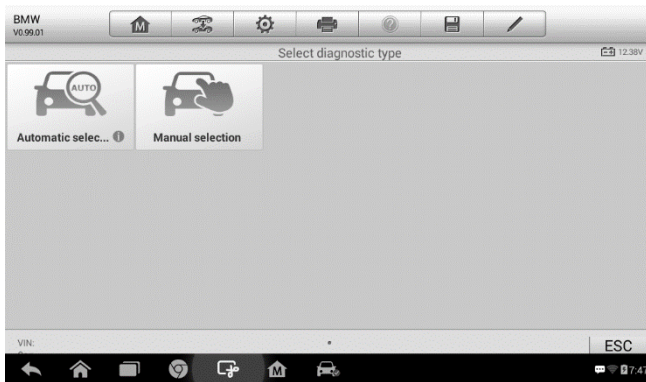

Figure 4-7 Sample Selection Screen

➤ To perform Automatic Selection

1. Tap the **Diagnostics** application button from the MaxiCOM Job Menu. The Vehicle Menu displays.
2. Tap the vehicle brand of the test vehicle.
3. Tap **Automatic Selection** and the system will proceed to acquire the VIN. Follow the on-screen instruction to access the diagnostic screen.

Manual Selection

When the vehicle's VIN is not automatically retrievable through the vehicle's ECU, or the specific VIN is unknown, you can choose to select the vehicle manually.

This mode of vehicle selection is menu driven, repeat the first two steps from the automatic selection operation and tap **Manual Selection**. Follow the on-screen prompts to make a series of choices to select the correct vehicle. Press the **Back** button at the bottom right corner of the screen to return to the previous step. Exact procedures may vary by vehicle.

Navigation

This section describes how to operate the Diagnostics screen and select test options.

Diagnostics Screen Layout

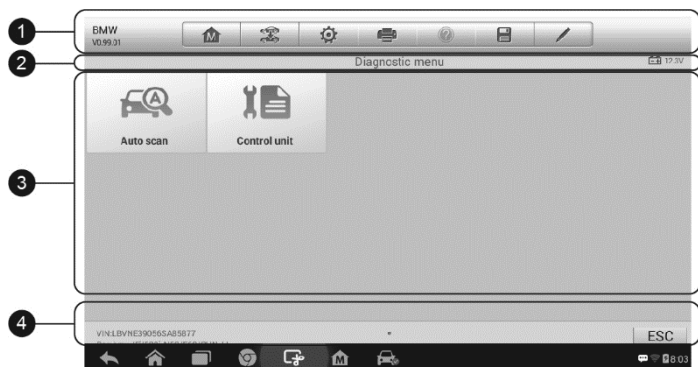

Figure 4-8 Sample Diagnostics Screen







The diagnostic screens typically include four sections.

1. Diagnostics Toolbar
2. Status Information Bar
3. Main Section
4. Functional Buttons

Diagnostics Toolbar

The Diagnostics Toolbar contains a number of buttons that allow you to perform various functions. The table below provides a brief description for the operations of the Diagnostics Toolbar buttons.

Table 4-2 Diagnostics Toolbar Buttons

Button	Name	Description
	Home	Returns to the MaxiCOM Job Menu.
	Vehicle Swap	Exits the current diagnostic session of selected vehicle, and returns to the vehicle menu screen to select another vehicle for testing.
	Settings	Opens the settings screen. See Settings Operations on page 80.
	Print	Prints a copy of the displayed data. See Printing Setting for additional information on page 82.
	Help	Displays operational instructions or tips.
	Save	Tap this button to open a sub menu, tap Save This Page to take a screenshot. All saved data is stored in the Data Manager application for later reviews. See Data Manager Operations on page 74.
	Data Logging	Records the communication data and ECU information of the test vehicle. The saved data can be reported and sent to Autel's technical center via the Internet. You can go to the Support application to follow up the processing progress, see Data Logging on page 96 for detailed information.

➤ To print data in Diagnostics

1. Tap the **Diagnostics** application button from the MaxiCOM Job Menu. The **Print** button on the diagnostic toolbar is available throughout the Diagnostics operations.

2. Tap **Print**. A drop-down menu displays. Tap **Print This Page** to print a screenshot of the current screen.
3. A temporary file will be created and send to the connected computer for printing.
4. When the file is transferred successfully, a confirmation message displays.

➤ **To submit Data Logging reports in Diagnostics**

1. Tap the **Diagnostics** application button from the MaxiCOM Job Menu. The **Data Logging** button on the diagnostic toolbar is available throughout the Diagnostics operations.
2. Tap the **Data Logging** button. The button displays blue during the active recording process.
3. Tap the **Data Logging** button again to end recording. A submission form will display for inputting of report information.
4. Tap the **Send** button to submit the report form via the Internet. A confirmation message displays when the report has been successfully sent.

Status Information Bar

The Status Information Bar at the top of the Main Section displays the following items:

1. Menu Title – displays the menu heading of the Main Section.
2. Voltage Icon – displays the vehicle's voltage status.

Main Section

The Main Section of the screen varies depending on the stage of operations. The Main Section can display vehicle identification selections, the main menu, test data, messages, instructions and other diagnostic information.

Functional Buttons

The displayed Functional Buttons vary depending on the stage of operations. Functional buttons can be used to navigate menus, to save or clear diagnostic data, to exit scanning and to perform a number of other control functions. The use of these buttons will be discussed in detail in the following sections of the corresponding test operations.

Screen Messages

Screen messages appear when additional input is needed before proceeding. There are three main types of on-screen messages: Confirmation, Warning, and Error.

Confirmation Messages

This type of messages usually displays as an “Information” screen that informs you when you are about to perform an action that cannot be reversed or when an action has been initiated and your confirmation is needed to continue.

When a user-response is not required to continue, the message displays briefly.

Warning Messages

This type of messages displays a warning that a selected action may result in an irreversible change or loss of data. The typical example of this is the “Erase Codes” message.

Error Messages

Error messages display when a system or procedural error has occurred. Examples of possible errors include a disconnection or communication interruption.

Making Selections

The Diagnostics application is a menu driven program that presents a series of choices. As a selection is made, the next menu in the series displays. Each selection narrows the focus and leads to the desired test. Tap the screen to make menu selections.

Diagnosis

The Diagnostics application enables a data link to the electronic control system of the test vehicle for vehicle diagnosis. The application performs functional tests, retrieves vehicle diagnostic information such as trouble and event codes and live data for various vehicle control systems, such as engine, transmission, and ABS.

There are two options available when accessing the Diagnosis section:

1. Auto Scan – starts auto scanning for all the available systems on the vehicle.
2. Control Units – displays a selection menu of all available control units of the test vehicle.

After a selection is made and the tablet establishes communication with the vehicle, the corresponding function menu or selection menu displays.

Auto Scan

The Auto Scan function performs a comprehensive scanning of the ECUs in the vehicle's system to locate and retrieve DTCs. The sample operation screen of Auto Scan displays as below:

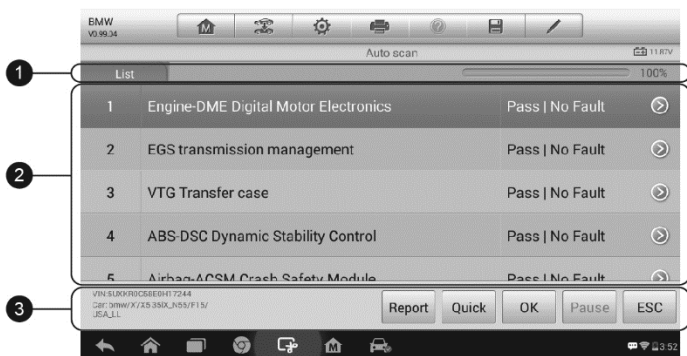

Figure 4-9 Sample Auto Scan Operation Screen

1. Navigation Bar
2. Main Section
3. Functional Buttons

Navigation Bar

List Tab – displays the scanned data in list format.

Progress Bar – indicates the test progress.

Main Section

Column 1 – displays the sequence numbers.

Column 2 – displays the scanned systems.

Column 3 – displays the diagnostic indicators describing test results.

These indicators are defined as follows:

- ❖ **-!-**: Indicates that the scanned system may not support the code reading function, or there is a communication error between the Display Tablet and the control system.
- ❖ **-?-**: Indicates that the vehicle control system has been detected, but the Display Tablet cannot accurately locate it.
- ❖ **Fault(s) | #**: Fault(s) indicates there is/are detected fault code(s) present; “#” indicates the number of the detected faults.
- ❖ **Pass | No Fault**: Indicates the system has passed the scanning process and no fault has been detected.

Column 4 – to perform further diagnosis or testing on a specific system item, tap the  button to the right of that item. A Function Menu screen will display.

Functional Buttons

A brief description of the operations of the Auto Scan's Functional Buttons' are displayed in the table below.

Table 4-3 Functional Buttons in Auto Scan

Name	Description
Report	Displays the diagnostic data in the report form.
Quick Erase	Deletes codes. A warning message screen will display to inform you of possible data loss when this function is selected.
OK	Confirms the test result. Continues to the system diagnosis after the required system is selected by tapping the item in the Main Section.
Pause	Suspends scanning and it will change to Continue button after tapped.

Name	Description
ESC	Returns to the previous screen or exits Auto Scan.

Control Units

This option allows you to manually locate a required control system for testing through a series of choices. Follow the menu driven procedures and make proper selection each time; the program will guide you to the diagnostic function menu after selections are made.

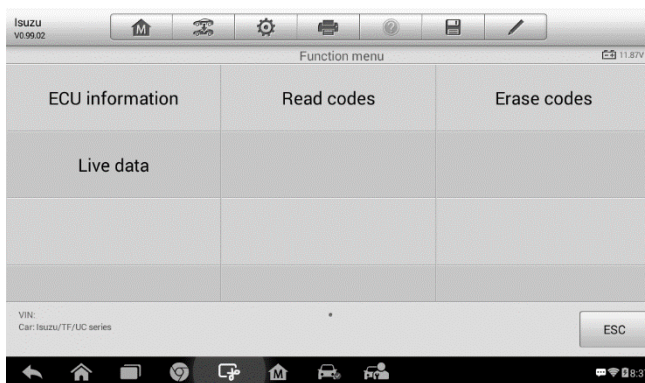

Figure 4-10 Sample Function Menu

The Function Menu options vary slightly for different vehicles. The function menu may include:

- **ECU Information** – provides the retrieved ECU information in detail. Selecting opens an information screen.
- **Read Codes** – displays detailed information of DTC records retrieved from the test vehicle's ECU.
- **Erase Codes** – erases DTC records and other data from the test vehicle's ECU.
- **Live Data** – retrieves and displays live data and parameters from the test vehicle's ECU.

NOTE

With the diagnostic toolbar on top of the screen throughout the whole diagnostic procedures, you are allowed to make various controls of the

diagnostic information at any time, such as printing and saving the displayed data, getting help information, or performing data logging, etc.

➤ **To perform a diagnostic function**

1. Establish communication with the test vehicle.
2. Identify the test vehicle by selecting from the menu options.
3. Select the **Diagnosis** section.
4. Locate the required system for testing by **Auto Scan** or through menu driven selections in **Control Units**.
5. Select the desired diagnostic function from the **Function Menu**.

ECU Information

This function retrieves and displays the specific information for the tested control unit, including unit type, version numbers and other specifications.

The sample ECU Information screen displays as below:

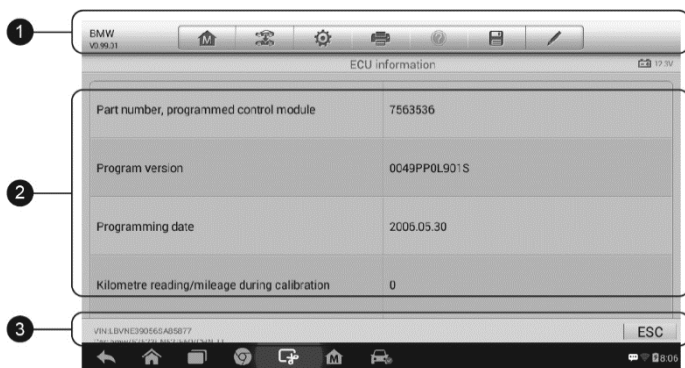

Figure 4-11 Sample ECU Information Screen

1. Diagnostics Toolbar Buttons – see [Table 4-2 Diagnostics Toolbar Buttons](#) on page 21 for detailed descriptions of the operations for each button.
2. Main Section – the left column displays the item names; the right column shows the specifications or descriptions.
3. Functional Button – in this case, only an **ESC** (or sometimes a **Back**) button is available; tap it to exit after viewing.

Read Codes

This function retrieves and displays the DTCs from the vehicle's control system. The Read Codes screen varies for each vehicle being tested. On some vehicles, freeze frame data can also be retrieved for viewing. The sample Read Codes screen displays as below:

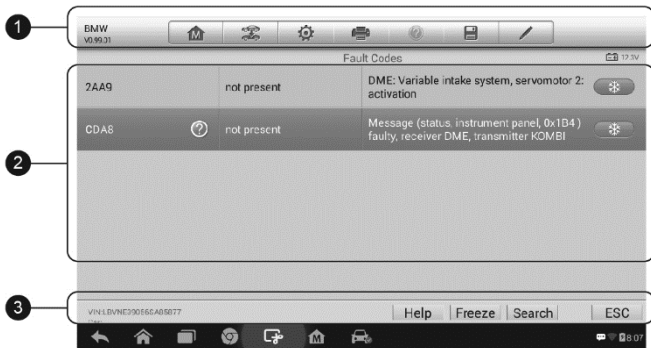

Figure 4-12 Sample Read Codes Screen

1. Diagnostics Toolbar Buttons – see [Table 4-2 Diagnostics Toolbar Buttons](#) on page 21 for detailed descriptions of the operations for each button.
2. Main Section
 - Code Column – displays the retrieved codes from the vehicle.
 - Status Column – indicates the status of the retrieved codes.
 - Description Column – detailed descriptions for the retrieved codes.
 - Snowflake Icon – only displays when freeze frame data is available for viewing; selecting this icon will display a data screen that looks very similar to the Read Codes screen.
3. Functional Button
 - Help – tap this to view fault code, including fault description, condition for fault identification, and driver information.
 - Freeze frame – tap this to view the freeze frame data.
 - Search – tap this icon to search fault code related information in Google.

- ESC – tap it to return to the previous screen or exit the function.

Erase Codes

After reading the retrieved codes from the vehicle and certain repairs have been carried out, you can erase the codes from the vehicle using this function. Before performing this function, make sure the vehicle's ignition key is in the ON (RUN) position with the engine off.

➤ **To erase codes**

1. Tap **Erase Codes** from the Function Menu.
2. A warning message displays to inform you of data loss if this function is completed.
 - a) Tap **Yes** to continue. A confirming screen displays when the operation is successfully done.
 - b) Tap **No** to exit.
3. Tap **ESC** on the confirming screen to exit Erase Codes.
4. Perform the Read Codes function again to check if codes have been erased successfully.

Live Data

When this function is selected, the screen displays the data list for the selected module. The items available for any control module vary from one vehicle to another. The parameters display in the order that they are transmitted by the ECM, so expect variation between vehicles.

Gesture scrolling allows you to quickly move through the data list. Simply swipe the screen up or down to locate the data you want. The figure below shows a typical Live Data screen:

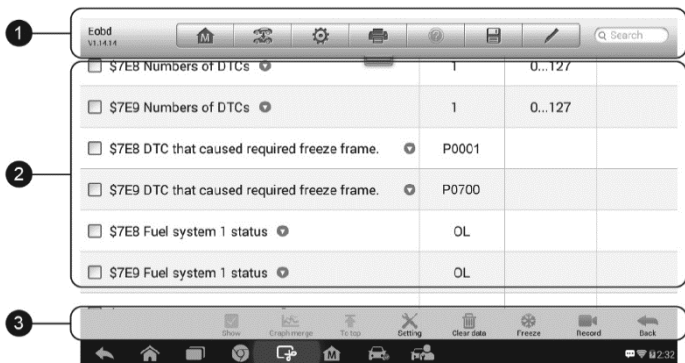

Figure 4-13 Sample Live Data Screen

1. Diagnostics Toolbar Buttons – tap the drop-down button at the top center of the screen and the toolbar buttons will display. See [Table 4-2 Diagnostics Toolbar Buttons](#) on page 21 for detailed descriptions of the operations for each button.
2. Main Section
 - Name Column – displays the parameter names.
 - a) Check Box – tap the check box on the left side of the parameter name to make item selection. Tap the check box again to de-select the item.
 - b) Drop-down Button – tap the drop-down button on the right side of the parameter name to open a sub menu that provides various choices for data display mode.
 - Value Column – displays the values of the parameter items.
 - Unit Column – displays the unit for the parameters.
 - To change the unit mode, tap the **Setting** button on the top toolbar and select a required mode. See [Unit](#) on page 80 for more information.

Display Mode

There are four types of display modes available for data viewing, allowing you to view various types of parameters in the most suitable way.

Tapping the drop-down button on the right side of the parameter name to open a sub menu. There are four buttons to configure the data display mode, and a Help button for access to additional information.

Each parameter item displays the selected mode independently.

- 1) Analog Gauge Mode – displays the parameters in form of an analog meter graph.
- 2) Text Mode – this is the default mode that displays the parameters in texts and displays in list format.

 **NOTE**

Reading of status parameters, such as a switch reading, which are mostly in word form, such as ON, OFF, ACTIVE, and ABORT, can only be displayed in Text Mode. Whereas reading of value parameters, such as a sensor reading, can be displayed in text mode and other graph modes.

- 3) Waveform Graph Mode – displays the parameters in waveform graphs.

When this mode is applied, three control buttons will display on the right side of the parameter item, allowing you to manipulate the display status.

- Text Button – resumes Text Display Mode.
- Scale Button – changes the scale values, which are displayed below the waveform graph. There are four scales available: x1, x2, x4 and x8.
- Zoom-in Button – tap once to display the selected data graph in full screen.
 - ✧ Edit Button – tap this button to open an edit window, on which you can set the waveform color and the line thickness displayed for the selected parameter item.
 - ✧ Scale Button - changes the scale values, which are displayed below the waveform graph. There are four scales available: x1, x2, x4 and x8.
 - ✧ Zoom-out Button – exits full screen display.
- 4) Digital Gauge Mode – displays the parameters in form of a digital gauge graph.

Full Screen Display – this option is only available in the waveform graph mode, and mostly used in Graph Merge status for data comparison.

There are three control buttons available on the top right side of the screen under this mode.

➤ **To edit the waveform color and line thickness in a data graph**

1. Select 1 to 3 parameter items to display in Waveform Graph mode.
2. Tap the **Zoom-in Button** on the right to display the data graph in full screen.
3. Select a parameter item on the left column.
4. Select a desired sample color from the middle column.
5. Select a desired sample line thickness from the right column.
6. Repeat steps 3-5 to edit the waveform for each parameter item.
7. Tap **Done** to save the setting and exit, or tap **Cancel** to exit without saving.

3. Functional Buttons

The operations of available functional buttons on Live Data screen are described below:

Back – returns to previous screen or exits the function.

Record – starts recording the retrieved live data; the recorded data is then stored as a video clip in the Data Manager application for future reviews. This function could be triggered automatically at preset threshold value or manually as you choose. The triggering mode and record duration can be configured in the Setting mode of Live Data.

Freeze frame – displays the retrieved data in freeze frame mode.

- Previous Frame – moves to the previous frame in the freeze frame data.
- Next Frame – moves to the next frame in the freeze frame data.

Clear Data – clears all previously retrieved parameter values at a selected point.

To Top – moves a selected data item to the top of the list.

Graph Merge – tap this button to merge selected data graphs (for Waveform Graph Mode only). This function is useful when making a comparisons between parameters.

NOTE

This mode supports Graph Merge for 2 to 3 parameter items.

- To cancel Graph Merge mode, tap the drop-down button on the right side of the parameter name, and select a data display mode.

Show – tap this option to switch between the two options; one displays the selected parameter items, the other displays all the available items.

Setting – tap this button to access setting screen to set the trigger mode, recording duration and threshold values for data recording, and define other control settings.

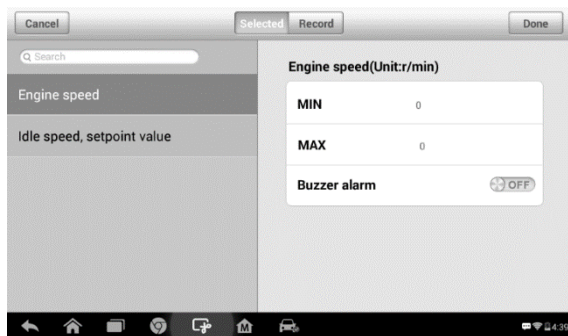

Figure 4-14 Sample Setting Mode in Live Data

There are four navigation buttons on top of the **Setting** mode screen.

- **Selected Button** – displays the configuration screen on which you can set the threshold values, an upper limit and a lower limit, for triggering the buzzer alarm. This function only applies to the Waveform Graph display mode.
 - a) **MIN** – tap to open a virtual keyboard, allowing you to enter the required lower limit value.
 - b) **MAX** – tap to open a virtual keyboard, allowing you to enter the required upper limit value.
 - c) **Buzzer Alarm** – switches the alarm on and off. The alarm function beeps as a reminder whenever the data reading reaches the pre-set minimum or maximum point.
- **To set threshold limits for the parameter values**

1. Tap the **Setting** functional button at the bottom of the Live Data screen.
2. Tap the **Selected** navigation button.
3. Select a parameter item on the left column, or enter the item name in the Search bar.
4. Tap on the right side of the **MIN** button, and enter the required minimum value.
5. Tap on the right side of the **MAX** button, and enter the required maximum value.
6. Tap the **ON/OFF** button on the right side of the Buzzer Alarm button to turn it on or off.
7. Tap **Done** to save the setting and return to the Live Data screen; or tap **Cancel** to exit without saving.



If the threshold limits are successfully set, two horizontal lines will appear on each of the data graphs (when Waveform Graph Mode is applied) to indicate the alarming point. The threshold lines are shown in different colors from the waveform of the parameters for distinction.

- **Record Button** – displays the configuration screen for Record Setting, on which you can set the trigger type, duration and trigger point for the data recording function.
 - a) **Trigger Type** – sets the trigger mode for data recording, mainly of two kinds: Manual and Auto. There are four options available:
 - 1) **Manual** – allows you to manually start and stop data recording
 - 2) **DTC** – auto triggers data recording when any DTC is detected
 - 3) **DTC Check Mode** – auto triggers data recording when certain pre-selected DTC types are detected
 - 4) **Parameter** – auto triggers data recording when any parameter value reaches the preset threshold
 - b) **Duration** – sets the recording time (for Auto trigger mode only)
 - c) **Trigger Point** – reserves a relative percentage of a record length before the data recording start point for reference (for Auto trigger mode only)

➤ **To perform setting for live data record**

1. Tap the **Setting** functional button at the bottom of the Live Data

screen.

2. Tap the **Record** navigation button.
 3. Tap the  button on the right of **Trigger Type** bar and select the required trigger mode.
 4. Tap the  button on the right of **Duration** bar and select a length of time.
 5. Tap the  button on the right of **Trigger Point** bar and select a relative percentage of a record length to be reserved before the data recording start point.
 6. Tap **Done** to save the setting and return to the Live Data screen; or tap **Cancel** to cancel without saving and exit Setting.
- **Done Button** - confirms and saves the setting, and returns you to the Live Data screen.
 - **Cancel Button** – cancels the setting operation, and returns you to the Live Data screen.

Generic OBD II Operations

A fast-access option for OBD II/E OBD vehicle diagnosis is available on the Vehicle Menu screen. This option presents a quick way to check for DTCs, isolate the cause of an illuminated malfunction indicator lamp (MIL), check monitor status prior to emissions certification testing, verify repairs, and perform a number of other services that are emissions-related. The OBD direct access option is also used for testing OBD II/E OBD compliant vehicles that are not included in the Diagnostics database.

Functions of the diagnostics toolbar buttons at the top of the screen are the same as those available for specific vehicle diagnostics. See [Table 4-2 Diagnostics Toolbar Buttons](#) on page 21 for details.

General Procedure

- **To access the OBD II/E OBD diagnostics functions**
 1. Tap the **Diagnostics** application button from the MaxiCOM Job Menu. The Vehicle Menu displays.
 2. Tap the **EOBD** button. There are two options to establish communication with the vehicle.

- **Auto Scan** – when this option is selected the diagnostic tool attempts to establish communication using each protocol in order to determine which one the vehicle is broadcasting on.
 - **Protocol** – when this option is selected the screen opens a submenu of protocols. A communication protocol is a standardized way of data communication between an ECM and a diagnostic tool. Global OBD may use several different communication protocols.
3. Select a specific protocol under the **Protocol** option. Wait for the OBD II Diagnostic Menu to display.

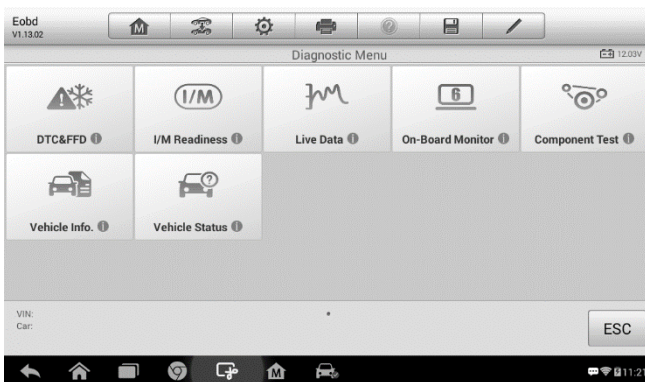

Figure 4-15 Sample OBD II Diagnostic Menu

NOTE

Tapping the **(i)** button beside the function name to display additional function information.

4. Select a function option to continue.
- **DTC & FFD**
 - **I/M Readiness**
 - **Live Data**
 - **On-Board Monitor**
 - **Component Test**
 - **Vehicle Information**

- **Vehicle Status**

 **NOTE**

Some functions are supported only on certain vehicle manufacturers.

Function Descriptions

This section describes the various functions of each diagnostic option:

DTC & FFD

When this function is selected, the screen displays a list of Stored Codes and Pending Codes. When the Freeze Frame data of certain DTCs are available for viewing, a snowflake button will display on the right side of the DTC item. The erase codes function can be applied by tapping the **Clear DTC** button at the bottom of the screen.

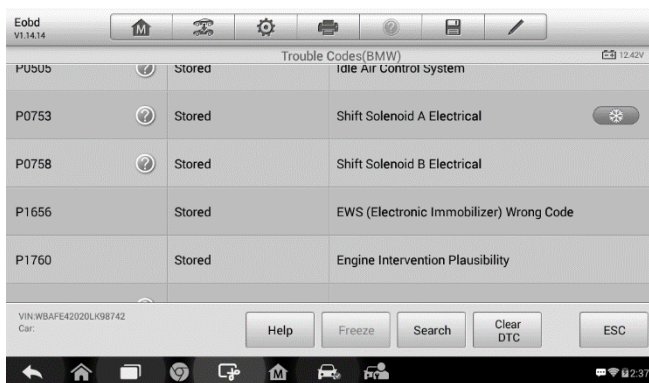

Figure 4-16 Sample DTC & FFD Screen

- **Stored Codes**

Stored codes are the current emission related DTCs from the ECM of the vehicle. OBD II/EOBD Codes have a priority according to their emission severity, with higher priority codes overwriting lower priority codes. The priority of the code determines the illumination of the MIL and the codes erase procedure. Manufacturers rank codes differently, so expect to see differences between makes.

- **Pending Codes**

These are codes whose setting conditions were met during the last drive cycle, but need to be met on two or more consecutive drive cycles before the DTC actually sets. The intended use of this service is to assist the service technician after a vehicle repair and after clearing diagnostic information, by reporting test results after a driving cycle.

- a) If a test failed during the driving cycle, the DTC associated with that test is reported. If the pending fault does not occur again within 40 to 80 warm-up cycles, the fault is automatically cleared from memory.
- b) Test results reported by this service do not necessarily indicate a faulty component or system. If test results indicate another failure after additional driving, then a DTC is set to indicate a faulty component or system, and the MIL is illuminated.

- **Freeze Frame**

In most cases the stored frame is the last DTC that occurred. Certain DTCs, which have a greater impact on vehicle emission, have a higher priority. In these cases, the top prioritized DTC is the one for which the freeze frame records are retained. Freeze frame data includes a “snapshot” of critical parameter values at the time the DTC is set.

- **Clear DTC**

This option is used to clear all emission related diagnostic data such as, DTCs, freeze frame data and manufacturer specific enhanced data from the vehicle’s ECM.

A confirmation screen displays when the clear codes option is selected to prevent accidental loss of data. Select **Yes** on the confirmation screen to continue or **No** to exit.

I/M Readiness

This function is used to check the readiness of the monitoring system. It is an excellent function to use prior to having a vehicle inspected for compliance to a state emissions program. Selecting I/M Readiness opens a submenu with two choices:

- **Since DTCs Cleared** – displays the status of monitors since the last time the DTCs are erased.
- **This Driving Cycle** – displays the status of monitors since the beginning of the current drive cycle.

Live Data

This function displays the real time PID data from ECU. Displayed data includes analog inputs and outputs, digital inputs and outputs, and system status information broadcast on the vehicle data stream.

Live data can be displayed in various modes, see [Live Data](#) on page 29 for detailed information.

On-Board Monitor

This option allows you to view the results of On-Board Monitor tests. The tests are useful after servicing or after erasing a vehicle's control module memory.

Component Test

This service enables bi-directional control of the ECM so that the diagnostic tool is able to transmit control commands to operate the vehicle systems. This function is useful in determining whether the ECM responds to a command well.

Vehicle Information

The option displays the vehicle identification number (VIN), the calibration identification, and the calibration verification number (CVN), and other information of the test vehicle.

Vehicle Status

This item is used to check the current condition of the vehicle, including communication protocols of OBD II modules, amount of codes, status of the Malfunction Indicator Light (MIL), and additional information.

Exiting Diagnostics

The Diagnostics application remains open as long as there is active communication with the vehicle. You must exit the diagnostics operation to stop all communications with the vehicle before closing the Diagnostics application.



NOTE

Damage to the vehicle electronic control module (ECM) may occur if communication is disrupted. Make sure all connections, such as USB cable and wireless connections, are properly connected at all times during testing. Exit all tests before disconnecting the test connection or powering down the tool.

➤ **To exit the Diagnostics application**

1. From an active diagnostic screen, tap the **Back** or **ESC** functional button to exit a diagnostic session step-by-step.
2. Or tap the **Vehicle Swap** button on the diagnostics toolbar to return to the Vehicle Menu screen.
3. From the Vehicle Menu screen, tap the **Home** button on the top toolbar; or tap the **Back** button on the navigation bar at the bottom of the screen.
4. Or tap the **Home** button on the diagnostics toolbar to exit the application directly and return to the MaxiCOM Job Menu.

Once the Diagnostics application is no longer communicating with the vehicle, it is safe to open other MaxiCOM applications, or exit the MaxiCOM Diagnostic System and return to the Android System's Home screen.

5 Service Operations

The Service section is specially designed to provide you with quick access to the vehicle systems for various scheduled service and maintenance performances. The typical service operation screen is a series of menu driven executive commands. By following the on-screen instructions to select appropriate execution options, enter correct values or data, and perform necessary actions, the system will guide you through the complete performance for various service operations.

The most commonly performed service functions include:

- Oil Reset Service
- EPB Service
- BMS Service
- SAS Service
- DPF Service
- TPMS Service
- IMMO Service

After entering each special function, the displayed screen consists of two applications: **Diagnosis** and **Hot Functions**. The **Diagnosis** is for you to read/clear data since this is necessary after some special functions. **Hot Functions** consists of sub functions of the selected special function.

Oil Reset Service

This function allows you to perform reset for the Engine Oil Life system, which calculates an optimal oil life change interval depending on the vehicle driving conditions and climate. The Oil Life Reminder must be reset every time the oil is changed, so the system can calculate when the next oil change is required.

! IMPORTANT

Always reset the engine oil life to 100% after every oil change.

NOTE

All required work must be carried out before the service indicators are reset. Failure to do so may result in incorrect service values and cause DTCs to be stored by the relevant control module.

NOTE

For some vehicles, the scan tool can perform added functionality to reset additional service lights (maintenance cycle, service interval). Using BMW as an example, its service reset function includes engine oil, spark plugs, front/rear brakes, coolant, particle filter, brake fluid, micro filter, vehicle inspection, exhaust emission inspection and vehicle check.

All software screens shown in this manual are examples, actual test screens may vary for each vehicle being tested. Observe the menu titles and on-screen instructions to make correct option selections.

➤ **To perform oil reset functions**

1. Tap the **Service** application button from the MaxiCOM Job Menu.
2. Tap **Oil Reset** button and wait for the vehicle manufacturer screen. You can tap **VIN Scan** or the vehicle make to acquire vehicle VIN information and tap **Yes** to confirm. See [Vehicle Identification](#) on page 15 for detail.
3. Tap the function you want in the Oil Reset function list, the list may vary for different vehicles being tested.

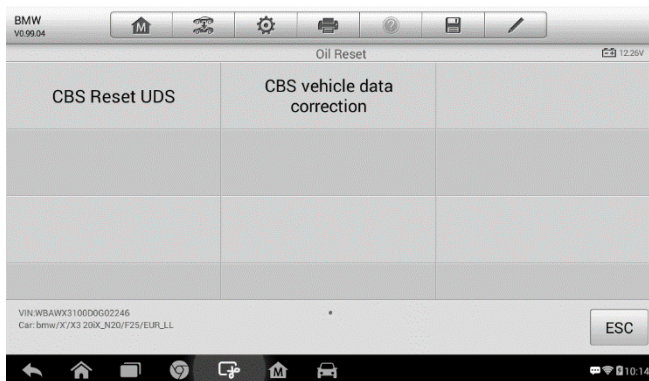

Figure 5-1 Sample Oil Reset Function List

- Follow the step-by-step on-screen instruction to complete the service. Using CBS Reset UDS as an example.
- Tap **CBS Reset UDS** on the Oil Reset function list to start the operation. The screen will guide you to confirm the date and time, if the displayed date and time are correct, tap **Yes** to confirm. If not, tap **No** and go to the Settings menu to set the correct date and time.

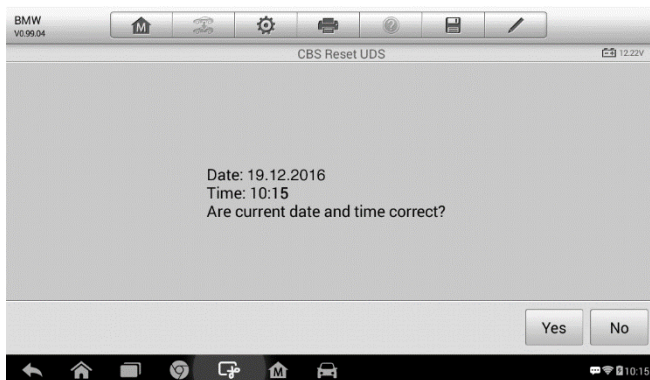

Figure 5-2 Sample Oil Reset Service Screen 1

- On the next screen, the available items would be listed with three columns displayed: CBS value, availability, and service counter.

CBS value	availability	service counter
Engine oil	32 %	5
Front Brake	97 %	9
Rear Brake	96 %	6

Figure 5-3 Sample Oil Reset Service Screen 2

7. Tap on the value you want to reset and then tap the **Reset** button on the right bottom of the screen.

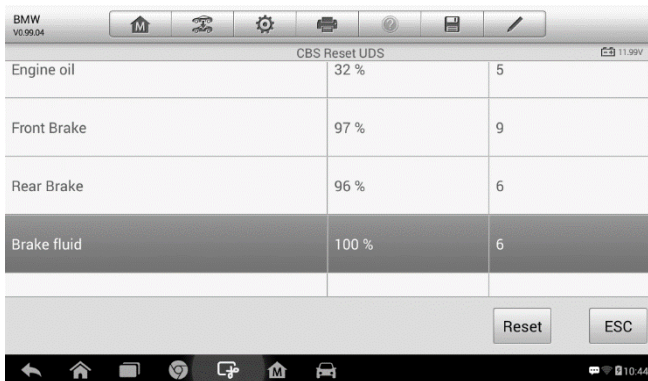

Figure 5-4 Sample Oil Reset Service Screen 3

8. When the reset is done, the availability would display as 100%. Tap **ESC** to exit.

Electronic Parking Brake (EPB) Service

This function has a multitude of usages to maintain the electronic braking system safely and effectively. The applications include deactivating and activating the brake control system, assisting with brake fluid control, opening and closing brake pads, and setting brakes after disc or pad replacement.

EPB Safety

It may be dangerous to perform Electronic Parking Brake (EPB) system maintenance, so before you begin the service work, please keep these rules in mind.

- ✓ Ensure that you are fully familiar with the braking system and its operation before commencing any work.
- ✓ The EPB control system may be required to be deactivated before carrying out any maintenance/diagnostic work on the brake system. This can be done from the tool menu.
- ✓ Only carry out maintenance work when the vehicle is stationary and on level ground.

- ✓ Ensure that the EPB control system is reactivated after the maintenance work has been completed.

NOTE

Autel accepts no responsibility for any accident or injury arising from the maintenance of the Electronic Parking Brake system.

➤ **To perform EPB functions**

1. Tap the **Service** application button from the MaxiCOM Job Menu.
2. Tap **EPB** button and wait for the vehicle manufacturer screen. You can tap **VIN Scan** or the vehicle make to acquire vehicle VIN information and tap **Yes** to confirm. See [Vehicle Identification](#) on page 15 for detail.
3. Tap the service you want in the EPB function list, the list may vary for different vehicles being tested.

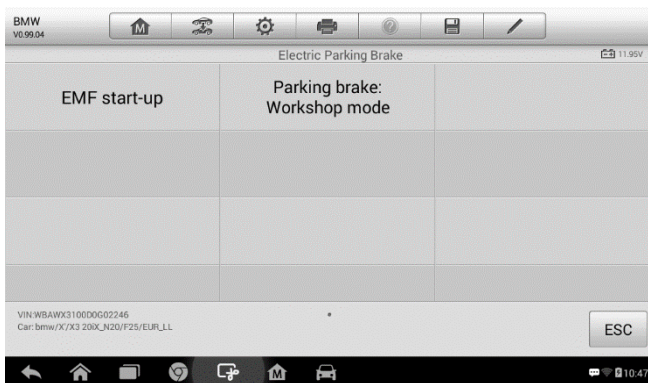

Figure 5-5 Sample EPB Function List

4. Follow the step-by-step on-screen instruction to complete the service.
5. Press **OK** button to exit.

EMF Star-up

This service function would start the parking brake, it must be conducted after the following repairs:

- Replacing an EMF control unit.
- Replacing the parking brake button.

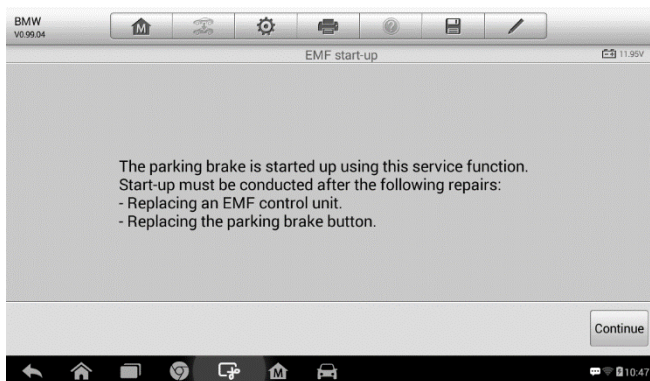

Figure 5-6 Sample EMF Star-up Screen 1

- 1) Tap **Continue** to proceed this service function or the **Back** button at the bottom left to exit.
- 2) Tap on the action taken to continue.

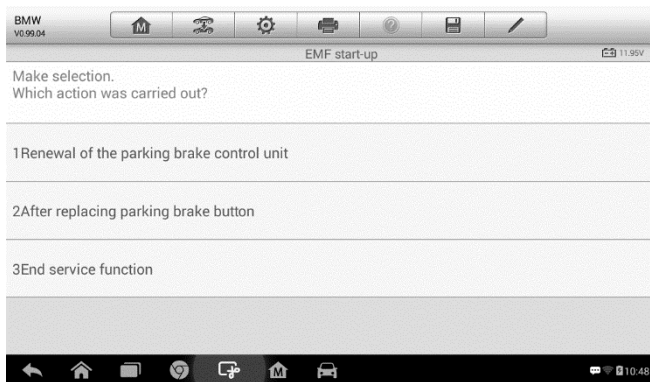

Figure 5-7 Sample EMF Star-up Screen 2

- 3) A screen will display to remind you that the fault memory of the parking brake control unit will be deleted, press **Continue** to proceed or the **Back** button to exit.

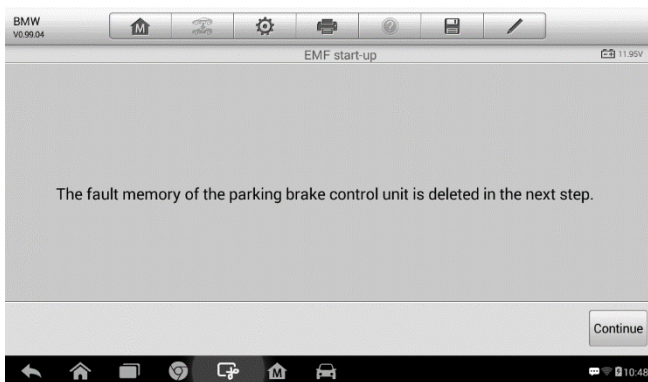

Figure 5-8 Sample EMF Star-up Screen 3

- 4) Follow the on-screen instructions to pull the parking brake button and wait for around 3 seconds until the parking brake is set. When the operation is successfully completed, a “Completed successfully” message will display on the screen. Press **OK** to exit.

Parking Brake: Workshop Mode

This service is used to activate and deactivate the so-called installation position for the Automatic Hold brake. In this mode, the parking brake is moved into the opened position and temporarily deactivated for personal protection.

The installation position must be activated for the following repairs:

- Replacement of brake pads.
- Replacement of a brake caliper.
- Replacement of an actuator.

Select **Parking Brake: Workshop Mode** and follow the on-screen instructions to perform a series of operations to start the brake pad after replacement.

When the operation is successfully completed, a “Completed successfully” message will appear on the screen. Press **OK** to exit.

BMS

The BMS (Battery Management System) allows the scan tool to evaluate the battery charge state, monitor the close-circuit current, register the battery replacement, and activate the rest state of the vehicle.

NOTE

1. This function is not supported by all vehicles. The screens shown in this section are examples.
 2. The sub functions and actual test screens of the BMS may vary by vehicle. Please follow the on-screen instructions to make the correct selection.
-

The vehicle may use either a sealed lead-acid battery or an AGM (Absorbed Glass Mat) battery. Lead acid battery contains liquid sulphuric acid and can spill when overturned. AGM battery (known as VRLA battery, valve regulated lead acid) also contains sulphuric acid, but the acid is contained in glass mats between terminal plates.

It is recommended that the replacement aftermarket battery have the same specifications, such as capacity and type, as the battery in the vehicle. If the original battery is replaced with a different type of battery (e.g. a lead-acid battery is replaced with an AGM battery) or a battery with a different capacity (mAh), the vehicle may require reprogramming the new battery type in addition to performing the battery reset. Consult the vehicle manual for additional vehicle-specific information.

Register Battery Replacement

This option allows displaying the mileage reading of last battery replacement, registering the battery replacement after replacing a new battery and informing the power management system that a new battery has been fitted to the vehicle.

If the battery change is not registered, the power management system will not function properly, which may not provide the battery with enough charging power to operate the car and limit the functions of individual electrical equipment.

Using **BMW** as an example.

- **To display the battery history**

1. Tap the **Service** application button from the MaxiCOM Job Menu.
2. Tap **BMS** button and wait for the vehicle manufacturer screen. Tap **VIN Scan** or the vehicle make to acquire vehicle VIN information and tap **Yes** to confirm. See [Vehicle Identification](#) on page 15 for detail.
3. Tap **Register Battery Replacement** in the **BMS** function list. The list may vary by vehicle.

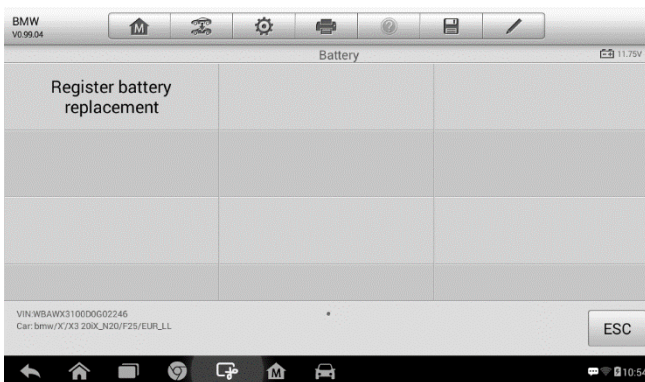

Figure 5-9 Sample BMS Function List

4. Tap on the desired service. In this example, Tap function 2 (**F2**) to choose the function **Battery exchange history display**. A notice screen displays.

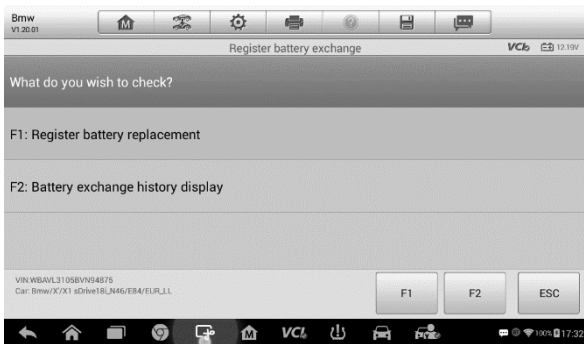

Figure 5-10 Sample BMS Screen 1

5. Read carefully the complete information and press **Continue**.

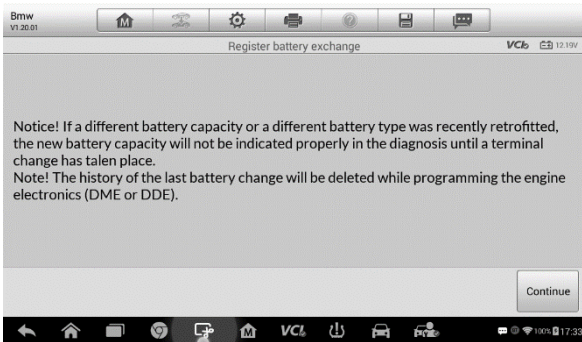

Figure 5-11 Sample BMS Screen 2

6. Check the battery capacity and the battery replacement information displayed.
7. Tap function 1 (**F1**) to return to the selection screen.

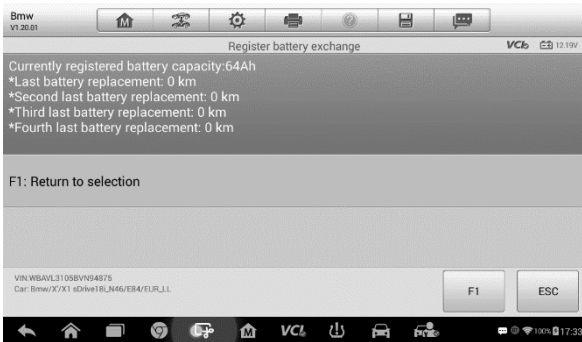

Figure 5-12 Sample BMS Screen 3

➤ **To register the battery replacement**

1. Tap on the appropriate step to complete. In our example, tap function 1 (**F1**) **Register battery replacement**.

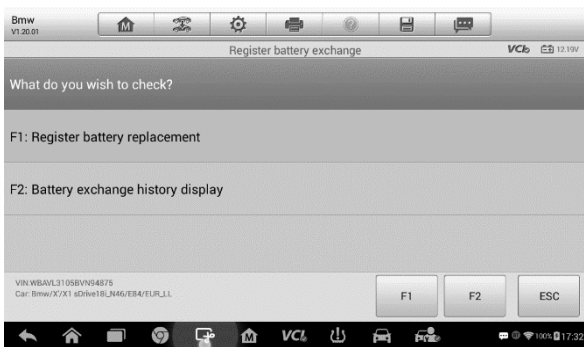

Figure 5-13 Sample BMS Screen 4

2. Read carefully the information on the screen. Scroll through lists to view all the functions.

There are three functions. Select function 1 (F1) for example.



Figure 5-14 Sample BMS Screen 5

- 1) Enter battery replacement: same capacity
- 2) Enter battery replacement: different capacity
- 3) Enter battery replacement: Changing from the normal lead-acid battery (white housing) to AGM battery (black housing)

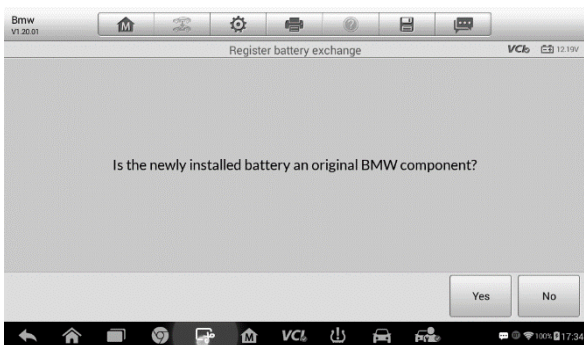

Figure 5-15 Sample BMS Screen 6

3. Read carefully the information on the screen and tap **Yes** to continue.
4. Follow the on-screen instructions to input the data matrix code of the newly installed battery that should be on the label of the battery. Tap **OK** to continue.

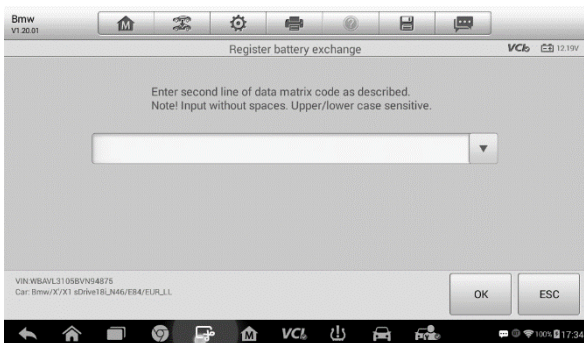

Figure 5-16 Sample BMS Screen 7

5. When the battery exchange is successfully entered, tap **Continue** to exit.

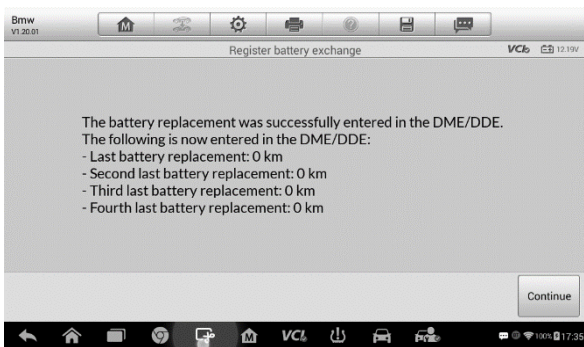

Figure 5-17 Sample BMS Screen 8

Steering Angle Sensor (SAS) Service

Steering Angle Sensor Calibration permanently stores the current steering wheel position as the straight-ahead position in the steering angle sensor EEPROM. Therefore, the front wheels and the steering wheel must be set exactly to the straight-ahead position before calibration. In addition, the vehicle identification number is also read from the instrument cluster and stored permanently in the steering angle sensor EEPROM. On successful completion of calibration, the steering angle sensor fault memory is automatically cleared.

Calibration must be completed after the following operations:

- Steering wheel replacement
- Steering angle sensor replacement
- Any maintenance involving opening the connector hub from the steering angle sensor to the column
- Any maintenance or repair work on the steering linkage, steering gear or other related mechanism
- Wheel alignment or wheel track adjustment
- Accident repairs where damage to the steering angle sensor or assembly, or any part of the steering system may have occurred

NOTE

1. AUTEL accepts no responsibility for any accident or injury arising from servicing the SAS system. When interpreting DTCs retrieved from the vehicle, always follow the manufacturer's recommendation for repair.
2. All software screens shown in this manual are examples, actual test screens may vary for each vehicle being tested. Observe the menu titles and on-screen instructions to make correct option selections.
3. Before starting the procedure, make sure the vehicle has an ESC button. Look for the button on dash.

Using **Land Rover** as an example.

1. Tap the **Service** application button from the MaxiCOM Job Menu.
2. Tap **SAS** button and wait for the vehicle manufacturer screen. You can tap **VIN Scan** or the vehicle manufacturer to acquire vehicle VIN information and tap **Yes** to confirm. See [Vehicle Identification](#) on page 15 for detail.
3. Tap the needed service in the SAS function list. The list may vary by vehicle.

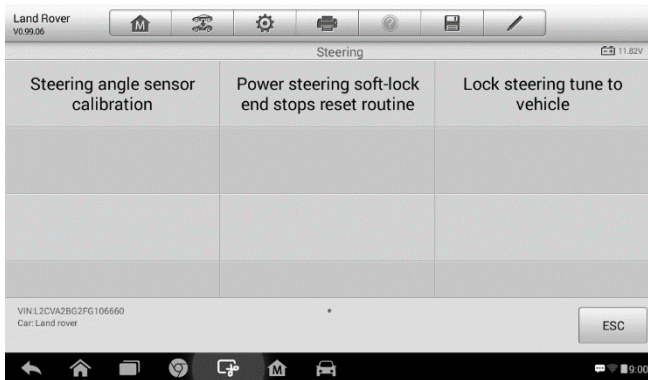

Figure 5-18 Sample SAS Function Menu

Steering Angle Sensor Calibration

This function allows users to perform steering angle sensor calibration and clear records. Available function options vary by vehicle.

- 1) Tap **Steering Angle Sensor Calibration** from the SAS function menu to enter the function screen.
- 2) Follow the on-screen instructions to set the ignition on/off as guided. The vehicle battery voltage signal should be in the range 12.5 – 13.5 volts to proceed with this service, otherwise the scan tablet will display a warning message.
- 3) Make sure the steering wheel is in the center position and the front wheels are straight. Then tap **OK** to proceed.

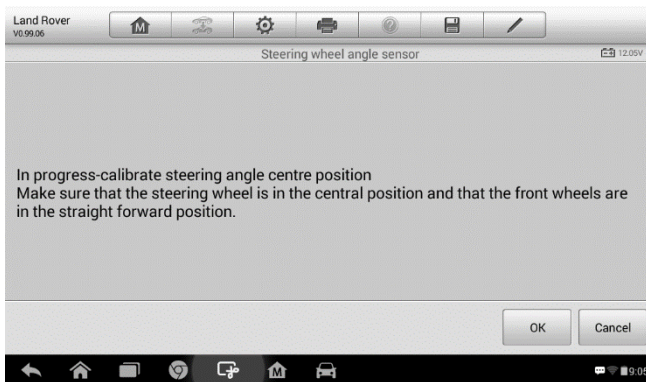

Figure 5-19 Sample SAS Function Screen 1

- 4) A confirmation message will display when the operation is complete. A message will display if operation could not be completed because of an existing issue. Repair problem after exiting the diagnostics application.

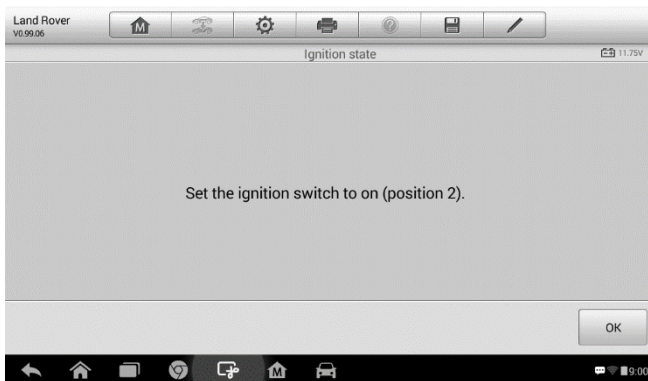

Figure 5-20 Sample SAS Function Screen 2

DPF Service

The DPF function allows you to carry out numerous functions to the Diesel Particulate Filter system. The tool will manage DPF regeneration, DPF component replacement teach-in and DPF teach-in after replacing the engine control unit.

The ECM monitors driving style and selects a suitable time to employ regeneration. Cars driven primarily at idling speed and low load will attempt to regenerate earlier than cars driven with higher loads and at higher speed. For regeneration to occur, a prolonged high exhaust temperature must be obtained.

In the event that the vehicle has been driven in such a way that regeneration is not possible, a diagnostic trouble code will be registered, DPF light and “Check Engine” indicator will display. A service regeneration can be performed using this tool.

Before carrying out a forced DPF regeneration, check the following items:

- The fuel light is not on.
- No DPF-relevant faults are stored in system.
- The vehicle has the correct spec engine oil.
- The oil for diesel is not contaminated.

❗ IMPORTANT

Before diagnosing a vehicle and attempting to perform an emergency regeneration, it is important to obtain a full diagnostic log and read out relevant measured value blocks.

🔧 NOTE

1. The DPF will not regenerate if the engine management light is on, or there is a faulty EGR valve.
 2. The ECU must be re-adapted when replacing the DPF and adding the fuel additive Eolys.
 3. If the vehicle needs to be driven in order to perform a DPF service, ALWAYS have a second person help you. One person should drive the vehicle while the other person observes the screen on the Tool. Trying to drive and observe the Scan Tool at the same time is dangerous, and could cause a serious traffic accident.
-

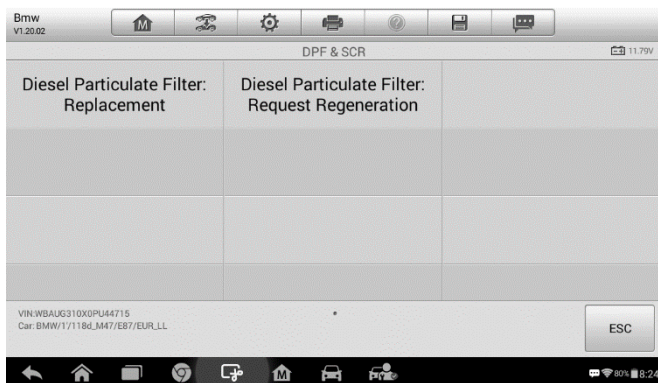

Figure 5-21 Sample DPF Service Function Menu

Diesel Particulate Filter: Replacement

This function enable you to reset the adaptation values.

1. Tap **Diesel Particulate Filter: Replacement** from the service functions menu to enter the service screen.
2. Read carefully the information on the screen and press **Continue**.

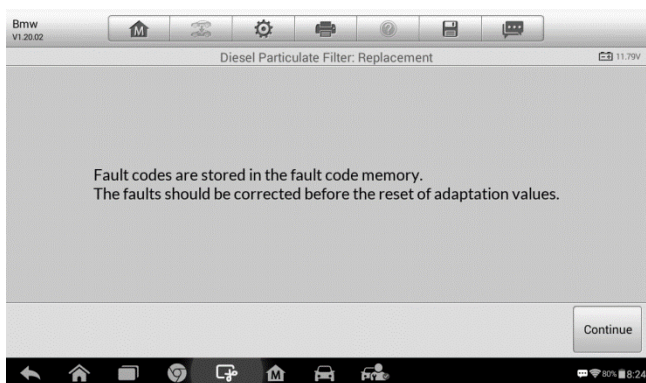

Figure 5-22 Sample Diesel Particulate Filter Screen 1

3. Tap function 1 (**F1**) to reset adaptation values for the particle filter.

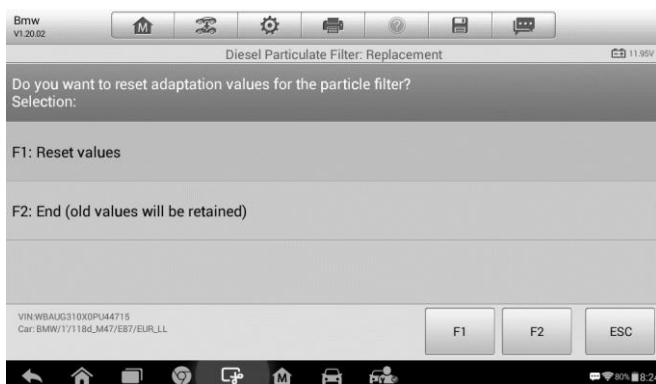

Figure 5-23 Sample Diesel Particulate Filter Screen 2

4. A confirmation message will display. Please tap **Yes** to continue.

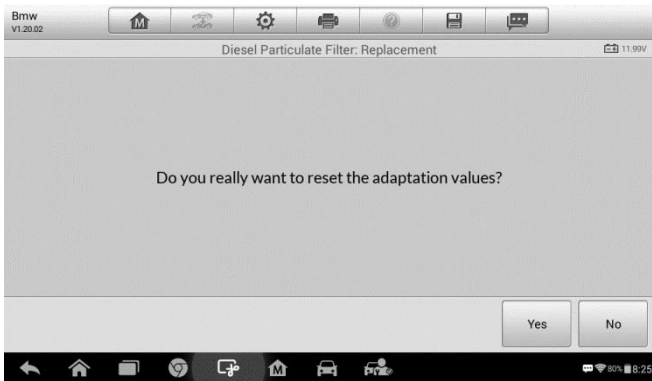

Figure 5-24 Sample Diesel Particulate Filter Screen 3

5. The adaptation values are reset successfully. Tap **Continue** to end the service function.

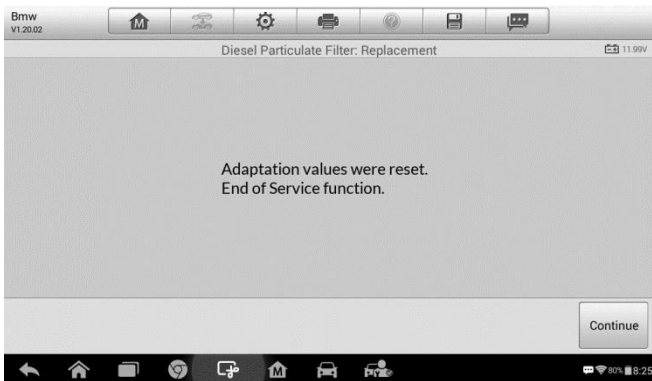

Figure 5-25 Sample Diesel Particulate Filter Screen 4

Diesel Particulate Filter: Request Regeneration

This function is used to perform a regeneration run when some problems caused by a clogged Diesel Particulate Filter (DPF) happen. Available function options vary by vehicle.

1. Tap **Diesel Particulate Filter: Request Regeneration** from the service functions menu.
2. The tool communicates with the vehicle and reads the fault codes memory. Follow the on-screen instructions to check the prerequisites before particle filter regeneration, such as the fuel, the time and driving style.
3. If every prerequisite is met, the tool will ask for confirmation to proceed as below. Tap **Yes** to request regeneration or **No** to end the service function and exit.

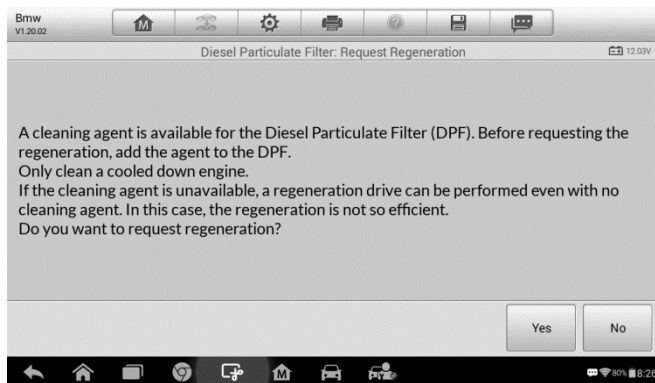

Figure 5-26 Sample Regeneration Confirmation Screen

4. Follow the on-screen instructions to perform the particle filter regeneration and tap **Continue**.

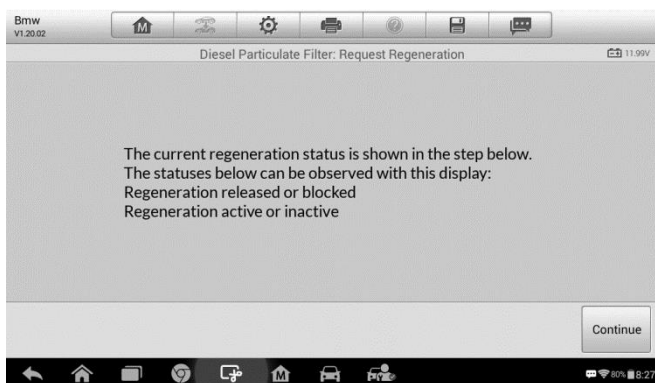

Figure 5-27 Sample Regeneration Status Screen

- When the particle filter regeneration is completed, the tool will ask for a confirmation to exit. Tap **F1** to re-check the status or tap **ESC** to exit.



Figure 5-28 Sample Status Display Confirmation Screen

Tire Pressure Monitor System (TPMS) Service

The TPMS service function include displaying sensor IDs from the vehicle's ECU, inputting TPMS sensor replacement IDs and testing sensors.

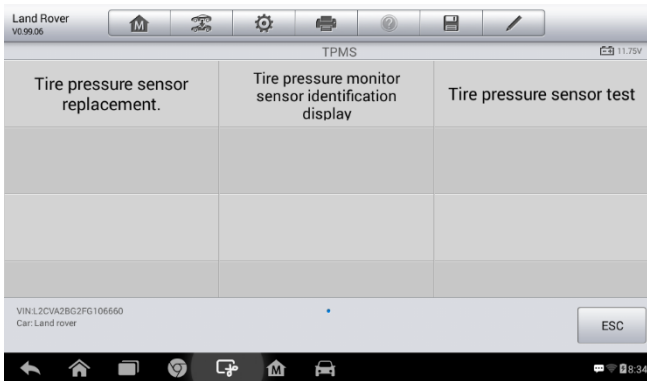

Figure 5-29 Sample TPMS Function Menu

Select tire pressure sensor replacement (Front left wheel sensor) as an example.

NOTE

This function will require the sensor ID be inputted on the screen.

The sensor IDs can be read directly from the sensor or by using a sensor activation tool that can read the ID.

Once the IDs have been entered, the vehicle may have to be driven at a certain speed for a certain time to complete procedure. Follow the instructions displays.

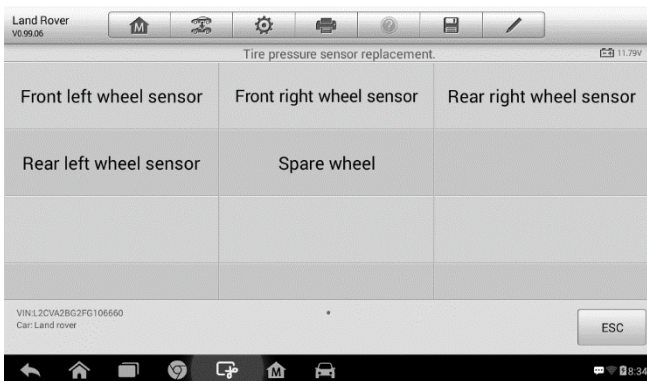

Figure 5-30 Sample Tire Pressure Sensor Replacement Screen

- 1) Tap **Front left wheel sensor** on the tire pressure sensor replacement menu.
- 2) Enter the 8 digit sensor identification as required. Press **OK**.

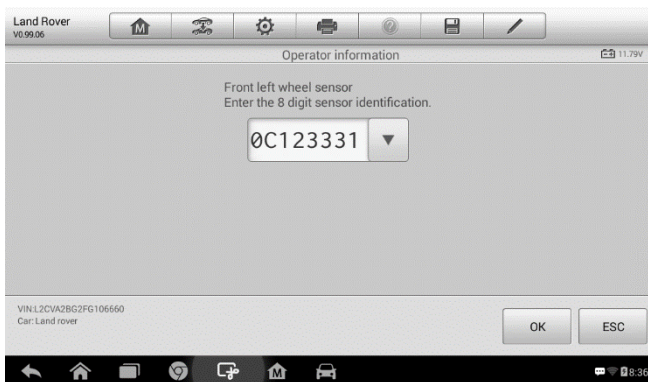

Figure 5-31 Sample Sensor ID Input Screen

- 3) Continue to select tire position and enter sensor IDs. A message will display when the entered IDs have been registered to the vehicle.

NOTE

The vehicle must remain stationary for at least 15 minutes with the ignition off, this will place the sensors into sleep mode. The vehicle must be driven for at least 15 minutes at a speed higher than 20 kph to ensure the module has learned the sensor identifications and positions.

For other services, please follow the on-screen instructions to operate.

On completion of the drive cycle, carry out the tire pressure monitor system test application.

IMMO Service

An immobilizer is an anti-theft mechanism that prevents an automobile's engine from starting if the correct ignition key is not used or other device is present. This device prevents thieves from starting the vehicle by a method known as hot wiring. Most new vehicles have an immobilizer as standard equipment. An important advantage of this system is that it doesn't require the vehicle owner to activate it; it operates automatically. An immobilizer is a more effective anti-theft protection than an audible alarm alone; many auto insurance companies offer lower rates for vehicles that are equipped with them.

As an anti-theft device, an immobilizer disables one of the systems needed to start a vehicle's engine, usually the fuel supply or the ignition. This is accomplished by radio frequency identification between a transponder in the ignition key and a device called a radio frequency reader in the steering column. When the key is placed in the ignition, the transponder sends a signal with a unique identification code to the reader that relays it to a receiver in the vehicle's computer control module. If the code is correct, the computer allows the fuel supply and ignition systems to operate and start the vehicle. If the code is incorrect or absent, the computer disables the system, and the vehicle will be unable to start until the correct key is placed in the ignition.

The IMMO service of MK808 enables you to disable the lost vehicle keys and program a replacement key fob. One or more replacement key fob can be programmed, depending on your needs.

- To program the replacement key fob(s)
 1. Tap **IMMO KEYS** after entering the **Service** function from the MaxiCOM Job Menu.
 2. Tap **Automatic Selection** or **Manual Selection** to acquire vehicle VIN information and tap **Yes** to confirm.
 3. Tap **Erase/Program all key fobs** in the IMMO function list after it is displayed, the list may vary for different vehicles being tested.

NOTE

- 1) To complete key fob programming, you need to acquire the Security Code, which can be acquired through the Security Code Read function in hot functions.
-

2) Before programming, please check and erase the fault codes.

4. Read the on-screen information carefully and follow the instructions to complete the operation.

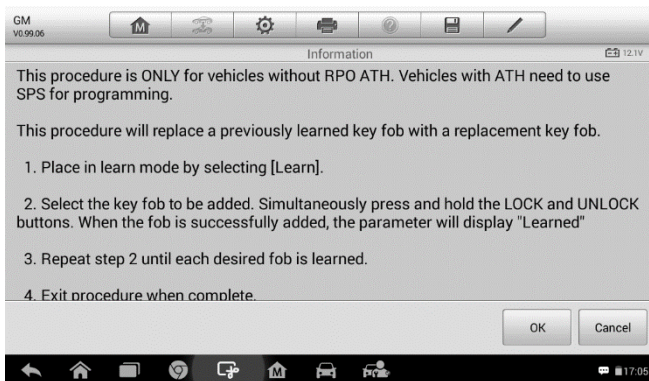

Figure 5-32 Sample IMMO Note Screen

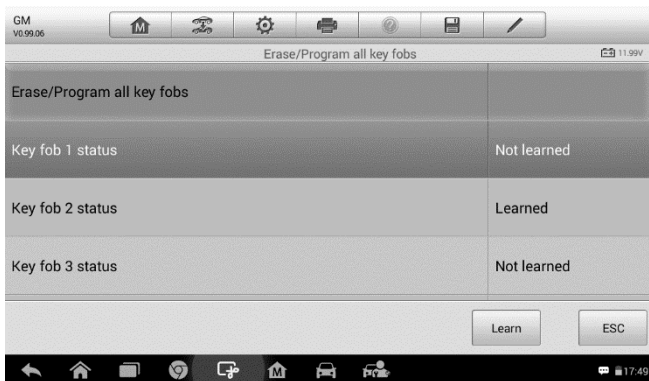

Figure 5-33 Sample Program Key FOB Screen







6 Shop Manager



The Shop Manager application manages the workshop information including customer information records and test vehicle history records. There are three main functions available:

- **Vehicle History**
- **Workshop Information**
- **Customer Manager**

The operations of these functions of the Shop Manager application are controlled by the toolbar buttons, which are listed and described in the table below:

Table 6-1 Top Toolbar Buttons in Shop Manager

Button	Name	Description
	Back	Returns to the previous screen.
	Diagnostics	Tap this button to access vehicle Diagnostics menu.
	Enter Edit	Tap this button to display the editing toolbar and print or delete the selected file.
	Delete	Tap this button to delete the selected vehicle record.
	Search	Enter the vehicle name or test path to retrieve vehicle record.
	Cancel	Tap this button to cancel editing or file search.
	Edit	Tap this button to edit information for the displayed file.

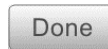
Button	Name	Description
	Add Account	Tap this button to create a new customer account file.
	History Notes	Tap this button to open a note form. Audio, video, image and text files may be attached.
	Vehicle History	Tap this button to display the Vehicle History with corresponding test vehicle records.
	Done	Complete editing and save the file.

Vehicle History

This function stores test vehicle history records, including vehicle information and the retrieved DTCs from previous diagnostic sessions. All information is displayed in summarized details. Tap on a record to resume a diagnostic session on a “stored vehicle”.

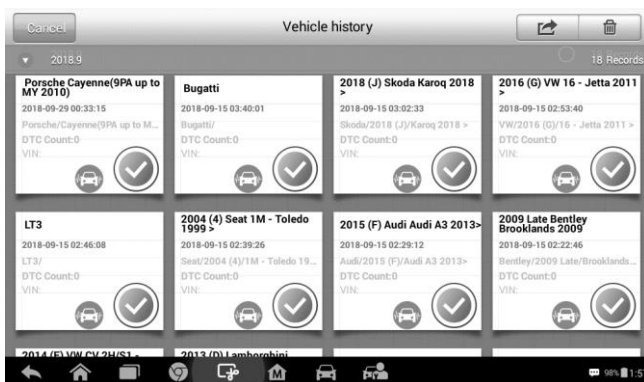

Figure 6-1 Sample Vehicle History Screen

- Top Toolbar Buttons** – navigates and makes various controls of the application.
 - Main Section** – displays all the vehicle history records information.
- **To activate a test session for the recorded vehicle**

1. Tap the **Shop Manager** application on the MaxiCOM Job Menu.
2. Select **Vehicle History**
3. Tap the **Diagnostics** button at the bottom of the thumbnail of a vehicle record item. Or,
4. Or, tap the vehicle record thumbnail to view record.
5. A Historical Test record sheet displays, check the recorded information of the recorded test vehicle, and tap the Diagnostics button on the upper right corner.
6. The vehicle's Diagnostics screen displays a new diagnostic session, see [Diagnosis](#) on page 23 for detailed instructions on vehicle diagnostic operations.

Historical Test Record

The Historical Test record sheet is a detailed data form that includes general vehicle information such as vehicle year, make and mode. The form also includes retrieved DTC from previous test and all information manually inputted by the technician.

The screenshot shows a mobile application interface for a 'Historical Test' record. The form is organized into several sections:

- Vehicle Info:** Includes fields for Year (2008), Make (Ford), Model (Mustang), SubModel, Engine, VIN, License, Color, and a 'Delete' button.
- Service Record:** Includes a field for Technician and a section for Technician Notes.
- Customer Info:** Includes fields for First Name and Last Name (John), and an 'Add to Customer' button.
- DTC:** A table with columns for Status, Description, and System. The current entry shows 'No data'.
- Actions:** A section with a plus sign icon for additional actions.

Figure 6-2 Sample Historical Test Record Sheet

- **To edit the Historical Test record sheet**
1. Tap the **Shop Manager** application on the MaxiCOM Job Menu.
 2. Select **Vehicle History**.
 3. Select the specific vehicle history record thumbnail from the main

section. The Historical Test record sheet displays.

4. Tap the **Edit** button to start editing.
5. Tap on each item to input the corresponding information or add relevant files or images.

NOTE

The vehicle VIN number, or license and the customer information account are correlated by default.

6. Tap **Add to Customer** to supplement a Historical Test record sheet to an existing customer account, or add a new associated account with the test vehicle record. See [Customer Manager](#) on page 70 for more information.
7. Tap **Done** to save the updated record sheet, or tap **Cancel** to exit without saving.

Workshop Information

Use the Workshop Information form to edit, input and save the detailed workshop information, such as shop name, address, phone number and other remarks, which when printing vehicle diagnostic reports and other associated test file, will display as the header of the printed documents.

The screenshot shows a mobile application interface for entering workshop information. The form is titled 'Workshop information' and includes the following input fields: Shop name, Address, Zip code, City, State, Tel, Fax, Manager name, Manager title, Email, and Website. The interface is designed for touch interaction, with a back arrow in the top left corner. The bottom of the screen displays a dock with several icons, including a home button, and a status bar at the very bottom showing the time as 8:28.

Figure 6-3 Sample Workshop Information Sheet

➤ **To edit the Workshop Information sheet**

1. Tap the **Shop Manager** application on the MaxiCOM Job Menu.

2. Select **Workshop Information**.
3. Tap the **Edit** button on the top toolbar.
4. Tap on each field to input the appropriate information.
5. Tap **Done** to save the updated workshop information sheet, or tap **Cancel** to exit without saving.

Customer Manager



Use the Customer Manager function to create and edit customer accounts and correlate with the associated test vehicle history records.

➤ **To create a customer account**

1. Tap the **Shop Manager** application on the MaxiCOM Job Menu.
2. Select **Customer Manager**.
3. Tap the **Add Account** button. An empty information form displays, tap each field to input the appropriate information.

 **NOTE**

Required fields are noted.

4. Tap the  photo frame beside the Name chart to add a photo. A sub menu displays, select **Take Photo** to take a new photo for the account, or select **Choose Photo** to choose from an existing images.
 5. If a customer adds or changes vehicles, tap **Add New Vehicle Information**, and input the vehicle information. Tap the  button to cancel.
 6. Tap **Done** to save the account, or tap **Cancel** to exit without saving.
- **To edit a customer account**
1. Tap the **Shop Manager** application on the MaxiCOM Job Menu.
 2. Select **Customer Manager**.
 3. Select a customer account by tapping the corresponding name card. A Customer Information sheet displays.
 4. Tap the **Edit** button on the top toolbar to start editing.
 5. Tap on the input field that needs to be altered or supplemented, and enter updated information.
 6. Tap **Done** to save the updated information, or tap **Cancel** to exit

without saving.

➤ **To delete a customer account**

1. Tap the **Shop Manager** application on the MaxiCOM Job Menu.
2. Select **Customer Manager**.
3. Select a customer account by tapping the corresponding name card. A Customer Information sheet displays.
4. Tap the **Edit** button on the top toolbar to start editing.
5. Tap the **Delete Customer Information** button. A confirmation message displays.
6. Tap **OK** to confirm the command, and the account is deleted. Tap **Cancel** to cancel the request.

History Notes

Use the History Notes function to add audio and video records, text notes and photos for the associated customer account.

➤ **To access History Notes**

1. Tap the **Shop Manager** application on the MaxiCOM Job Menu.
2. Select **Customer Manager** or **Vehicle History**.
3. Select a customer account by tapping the corresponding name card. A Customer Information sheet displays (if **Customer Manager** is selected). Or, select a vehicle history record item to open the Historical Test record sheet (if **Vehicle History** is selected).
4. Tap the **History Notes** button on the top bar. Now the History Notes screen displays.

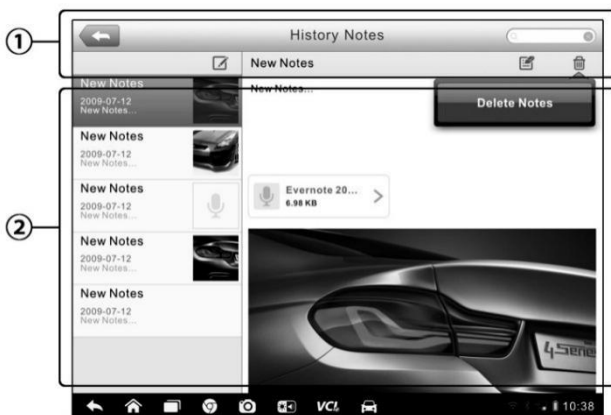





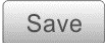

Figure 6-4 Sample History Notes Screen

- 1) **Functional Buttons** – navigates and performs various actions.
- 2) **Main Section** – displays the note list on the left column and the detail information of the selected note displays on the right column.

Table 6-2 Function Buttons in History Notes

Button	Name	Description
	Back	Returns to the previous screen.
	Delete	Deletes the selected note.
	Search	Quickly locates the required note by entering the note title.
	Cancel	Cancel edit or file search.
	Edit	Tap this button to open an edit window to edit notes.
	Add Notes	Adds new note in History Notes.
	Save	Saves notes.

➤ **To add a note in History Notes**

1. Access History Notes.
2. Tap the **Add Notes** button. An edit window displays.
3. Tap on the Title bar to input a note title.
4. Tap on the blank space below to edit a text note or remark.
5. Select a function button on the top to add files in any form you choose.
6. Tap **Save** to save the note; tap **Discard** or **Cancel** to exit without saving.

7 Data Manager

The **Data Manager** application is used to store, print, and review the saved files. Most operations are controlled through the toolbar.

Selecting the Data Manager application opens the file system menu. Different file types are sorted separately under different options, there are five types of information files to be viewed or played back.

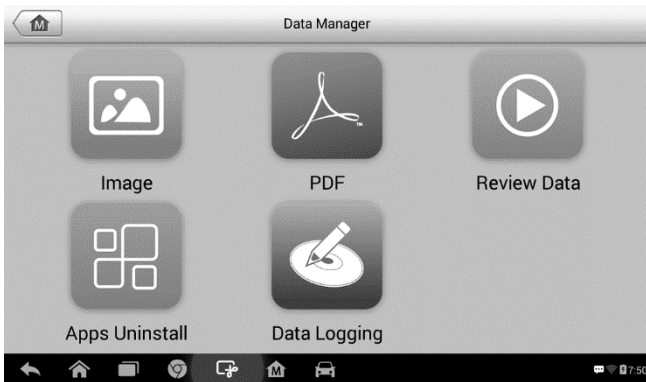

Figure 7-1 Sample Data Manager Main Screen

Operations

Data Manager Operations are based on toolbar controls. Details are explained in the following sections.

Image Files

The Image section contains all captured screenshot images.

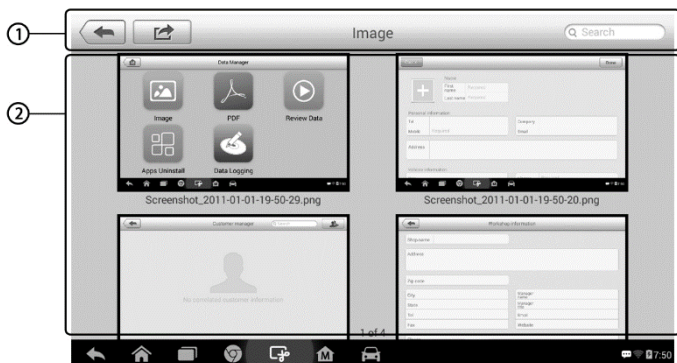









Figure 7-2 Sample Image Screen

1. **Toolbar Buttons** – used to edit, print and delete the image files. See the following table for detailed information.
2. **Main Section** – displays the stored images.

Table 7-1 Toolbar Buttons in Image

Button	Name	Description
	Back	Returns to the previous screen.
	Enter Edit	Tap this button to display the editing toolbar to print, delete or view image information.
	Cancel	Tap this button to close the editing toolbar or cancels file search.
	Search	Quickly locates the image file by entering the vehicle name, test path, file name or file info.
	Info	Tap this button to display the image details.

	Print	Tap this button to print the selected image.
	Delete	Tap this button to delete the selected image.

➤ **To edit image information**

1. Select **Data Manager** application from the MaxiCOM Job Menu.
2. Select **Image** to access the image database.
3. Select an image to display in full screen.
4. Tap the screen to display the editing toolbar.
5. Tap the **Info** button to display image information.
6. Tap the **Edit** button on the top right corner of the window. The editing screen displays.
7. Edit the image information by entering the new file name, and file information.
8. Tap **Done** to save the information and exit, or tap **Cancel** to exit without saving.

 **NOTE**

To print wirelessly, the printer driver must be installed on a Windows computer.

➤ **To install the printer driver program**

1. Please download the **Maxi PC Suite** from www.autel.com > Support & Updates > Firmware & Downloads > UPDATE CLIENT, and install to your PC. The Maxi PC Suite consists of Autel Printer, MaxiCOM Pinter and PC Suite.
2. Double click on **Setup.exe** item.
3. Select the installation language and the printer driver installation wizard will load.
4. Follow the wizard instructions on the screen and click **Next** to continue.
5. Click on **Install** and the printer driver program will be installed onto the computer.

6. Click on **Finish** to complete the installation procedure.
- **To delete selected images**
1. Select **Data Manager** application from the MaxiCOM Job Menu.
 2. Select **Image** to access the JPG database.
 3. Tap the **Enter Edit** button to display the editing toolbar.
 4. Select the images that need to be deleted by tapping the thumbnail images, the selected thumbnail displays a tick icon at the bottom right corner.
 5. Tap the **Delete** button, and then **Delete Selected**. The selected images will be deleted.

PDF Files

The PDF section stores and displays all PDF files of saved data. After entering the PDF database, select a PDF file to view the stored information.

This section uses the standard Adobe Reader application for file viewing and editing, please refer to the associated Adobe Reader manual for instructions.

Review Data

The Review Data section allows you to playback the recorded data frames of live data streams.

On the Review Data main screen, select a record file to playback.

Name	Value	Unit
<input type="checkbox"/> BUS Power Mode	Accessory	
<input type="checkbox"/> Transport Mode	Active	
<input type="checkbox"/> Vehicle Speed	0	km/h
<input type="checkbox"/> Vehicle Speed (CAN-Bus)	0	km/h
<input type="checkbox"/> Engine Speed	782	rpm
<input type="checkbox"/> OverSpeed Warning	Off	
<input type="checkbox"/> OverSpeed Function	Inactive	
<input type="checkbox"/> OverSpeed Buzzer	Enabled	
<input type="checkbox"/> Displayed Fuel Level	5	%

Figure 7-3 Sample Data Playback Screen

1. **Drop-down Toolbar** – tap the button at the top center of the screen to open the Drop-down Toolbar.
2. **Main Section** – displays the recorded data frames.
3. **Navigation Toolbar** – allows you to manipulate data playback.

Use the Navigation Toolbar buttons to playback the record data from frame to frame.

Tap **Back** to exit data playback.

Apps Uninstall

This section allows you to manage the firmware applications installed on the MaxiCOM Diagnostics System. Select this section to open a management screen, on which you can check all the available vehicle diagnostic applications.

Select the vehicle firmware you want to delete by tapping on the car brand icon, the selected item will display a blue mark at the upper right corner. Tap the **Delete** button on the top bar to delete the firmware from the system database.

Data Logging

The Data Logging section allows you to launch Support platform to view all

records of all sent or unsent (saved) data logs on the diagnostic system. For more details, please refer to [Data Logging](#) of Support operation on page 96.

8 Settings

Selecting Settings application opens a setup screen to adjust the default setting and view information about the MaxiCOM system. There are eight system settings:

- **Unit**
- **Language**
- **Printing Setting**
- **Notification Center**
- **Auto Update**
- **About**
- **System Settings**
- **Firmware**

This section describes the operation procedures for the settings.

Unit

This option allows you to change the measurement unit for the diagnostic system.

- **To adjust the unit setting**
 1. Tap the **Settings** application on the MaxiCOM Job Menu.
 2. Tap the **Unit** option on the left column.
 3. Select the required measurement unit, Metric or English. A check mark will display on the right of the selected unit.
 4. Tap the **Home** button on the top left corner to return to the MaxiCOM Job Menu or select another setting.

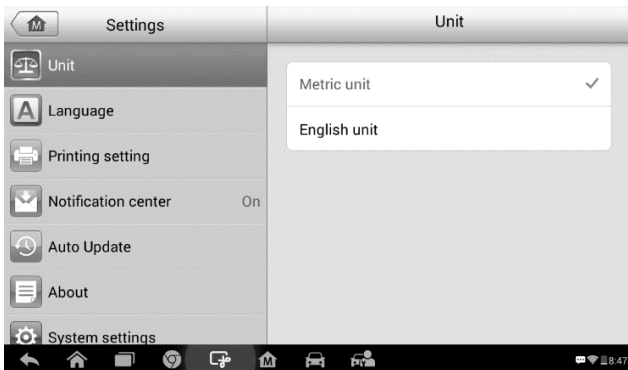

Figure 8-1 Sample Unit Setting Screen

Language

This option allows you to adjust the display language for the MaxiCOM system.

➤ To adjust the language setting

1. Tap the **Settings** application on the MaxiCOM Job Menu.
2. Tap the **Language** option on the left column.
3. Select the required language. A check mark will display on the right of the selected language.
4. Tap the **Home** button on the top left corner to return to the MaxiCOM Job Menu or select another setting.



Figure 8-2 Sample Language Setting Screen

Printing Setting

This option allows you to print via Wi-Fi connection.

➤ **To setup the printer connection**

1. Tap the **Settings** application on the MaxiCOM Job Menu.
2. Tap the **Printing Setting** option on the left column.
3. Tap the **Print via Network** item to activate the printing function that enables the device to send files to the printer through the PC via Wi-Fi connection.
4. Tap the **Home** button on the top left corner to return to the MaxiCOM Job Menu or select another setting.

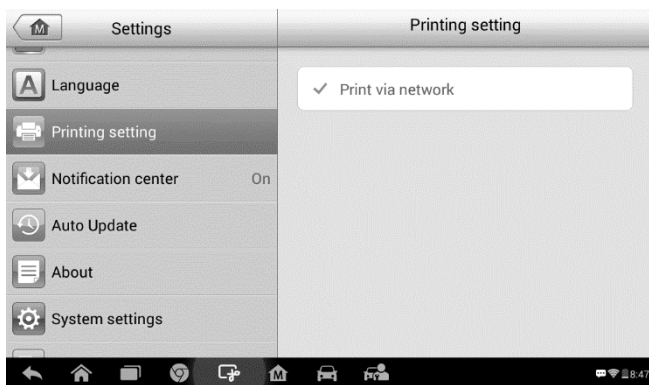

Figure 8-3 Sample Printing Setting Screen

NOTE

The MaxiCOM Printer runs automatically after the installation. The computer, printer and the tablet must be connected to the same network.

➤ **To perform printing via PC**

1. Run the **MaxiCOM Printer** on the computer.
2. Click **Test Print** to make sure the printer is working successfully.
3. Tap the **Print** button on the toolbar of the Display Tablet. A test document will be sent to the computer for printing.
 - ✧ If the **Auto Print** option in the MaxiCOM Printer is selected, the

MaxiCOM Printer will print the received document automatically.

- ✧ If the **Auto Print** option is not selected, click **Open PDF File** button to view all the temporary files. Select the file(s) you want to **print** and click Print.

➤ **To perform printing via APP**

The tablet does have the ability to print via APP to a Wi-Fi enabled printer. Download and install the Android APP compatible with your printer. To print a saved document, tap the **Print** button of a saved file on the tablet.

Notification Center

The Notification Center function configures the MaxiCOM tablet to receive regular system and service update notifications from Autel. To ensure you receive all such notifications, keep this function on at all times. Internet access is required.

➤ **To enable the Notification Center function**

1. Tap the **Settings** application on the MaxiCOM Job Menu.
2. Tap the **Notification Center** option on the left column.
3. Tap the **ON/OFF** button to enable or disable the Notifications function. If the function is enabled the button is blue, if disabled, the button is gray.
4. Tap the **Home** button on the top left corner to return to the MaxiCOM Job Menu or select another setting.

When the Notification Center function is on and messages are received by the MaxiCOM device, a notification message will display on the MaxiCOM Job Menu. Press on the message bar and drag it down. The received messages are displayed as a list. Slide the list up or down to scroll through messages.

Tap the specific message to launch its corresponding application. For example, if you tap on an Update notification message, the Update application will be launched.

Auto Update

The Auto Update allows the tool to automatically update the operating system, the MaxiCOM system and vehicle software. Tap the button on the right side of each software update to perform and set the time the automatic update should be done.

➤ **To set auto system or vehicle update**

1. Tap the **Settings** application on the MaxiCOM Job Menu.
2. Tap the **Auto Update** option on the left column. The three automatic updates are listed on the right.
3. Set the toggle button to ON to enable the automatic update feature for each update.

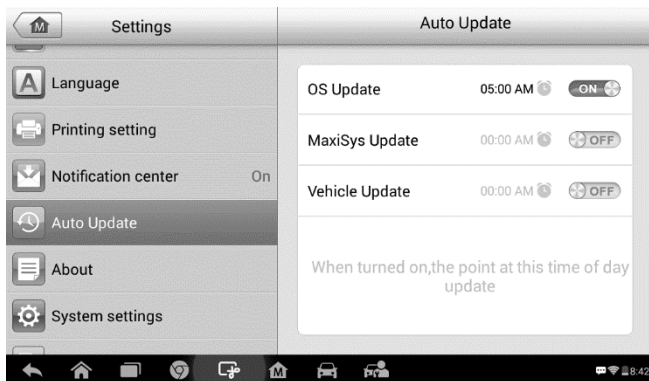

Figure 8-4 Sample Auto Update Screen

4. Tap on the time to set time. Tap the **+** and **-** button or tap on the numbers to manually adjust the time. Tap **Done** to complete the time setting.

NOTE

Ensure the tool is or will be connected to the Internet at the time the update is set to be conducted.

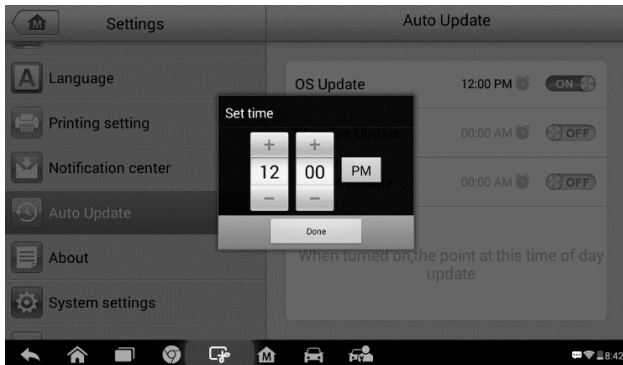

Figure 8-5 Sample Set Time Screen

About

The About screen lists the MaxiCOM's version, hardware, and serial number.

- **To check the MaxiCOM product information in About**
 1. Tap the **Settings** application on the MaxiCOM Job Menu.
 2. Tap the **About** option on the left column. The product information screen displays on the right.
 3. Tap the **Home** button on the top left corner to return to the MaxiCOM Job Menu, or select another setting option for the system setup after viewing.

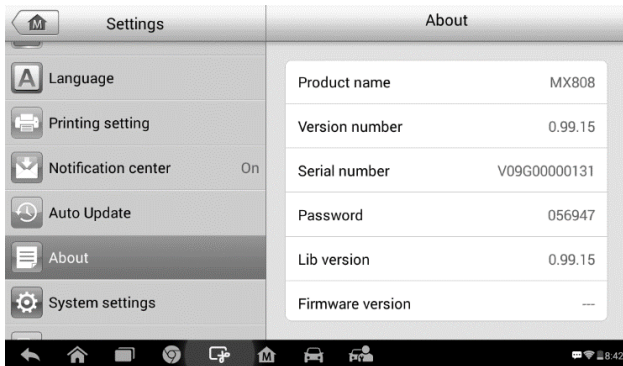

Figure 8-6 Sample About Screen

System Settings

Access the Android background system setting screen to adjust operating system settings including wireless and network settings and display and system security settings. Android device information is also displayed.

➤ **To enable the App Switcher function**

1. Tap the **Settings** application on the MaxiCOM Job Menu.
2. Tap the **System settings** option on the left column.
3. Tap the **App Switcher** option on the left column.
4. Mark the checkbox beside “Always show the App Switcher” on the right side of the screen. The App Switcher icon displays.

Short pressing the App Switcher icon to open a control panel:

- Tap a specific app shortcut button to be directed to the selected application screen.
- Long press a specific app shortcut button displays the app menu, on which you can select and change the app shortcut.
- Press and drag the App Switcher icon to another position alongside the edge of the screen.

Refer to Android documentation for information about Android system settings.

Firmware

This option allows you to update the firmware of the scan tool. Connect the scan tablet with the vehicle through DLC or use the mini USB cable for power supply. Follow the on-screen instructions to complete the operation. Internet connection is necessary for this operation.



Figure 8-7 Sample Firmware Screen

9 Update

The Update application allows you to download the latest released software. The updates can improve the MaxiCOM applications' capabilities, typically by adding new tests, new models, or enhanced applications.

The tablet automatically searches for available updates for the MaxiCOM software when it is connected to the internet. Any updates that are found can be downloaded and installed on the device. This section describes installing an update to the MaxiCOM System. If the Notification Center is enabled in the Settings application, a notification message will display when an update is available. (See [Notification Center](#) page 83 for details).

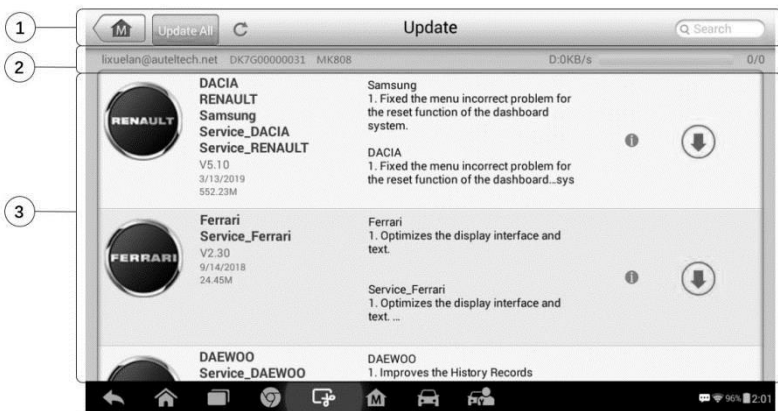

Figure 9-1 Sample Update Screen – for MaxiCOM MK808

① Navigation and Controls

- Home Button – returns to the MaxiCOM Job Menu.
- Update All – downloads all available updates.
- Diagnostics Tab – displays all available vehicle diagnostic software
- TPMS Tab – displays all available TPMS service software for vehicles.

- Search Bar – search specific update item by inputting the file name, for example: a vehicle make.

② Status Bar

- Left Side – displays the MaxiCOM device model information and serial number.
- Right Side – displays an update progress bar indicating the completion status.

③ Main Section

- Left Column – displays vehicle icons and update software version information; tap the **About** button displays a function list in PDF form with details about the software.
- Middle Column – displays a synopsis of the changes to the software. Tap ⓘ button to open an information screen to view details. Tap outside the information screen to close it.
- Right Column – controls software update. According to the status of the software download, a different titled button displays.
 - a) Tap **Update** to update the selected item.
 - b) Tap **Pause** to suspend the software update.
 - c) Tap **Continue** to resume updating the software.

➤ To update the diagnostic software and TPMS service software

1. Make sure the Display Tablet is connected to a power source with stable access to the internet.
2. Tap the **Update** application button from the MaxiCOM Job Menu; or tap the update notification message when received; or tap the **Update** icon on Vehicle Menu in Diagnostics application. The Update application screen displays.
3. Check all available updates:
 - If you decide to update all the items of diagnostic software, select **Diagnostics** Tab and then tap the **Update All** button; if you want to update all items of TPMS service software, select **TPMS** Tab and then tap the **Update All** button.
 - If you only want to update one or some of the item(s), tap the **Update** button on the right column of the specific item(s).

4. Tap the **Pause** button to suspend the update. Tap **Continue** to resume the update. The update will resume from the point at which it was paused.
5. The firmware will be installed automatically once its download has completed. The previous version will be replaced.

10 Support

This application launches the Support platform which synchronizes Autel's on-line service base station with the Display Tablet. In order to synchronize the device to your on-line account, you need to register the product through the Internet when you use it for the first time. The Support application is connected to Autel's service channel and on-line communities which provides the quickest way for problem solutions, allowing you to submit complaints or sent help requests to obtain direct services and supports.

Product Registration

In order to get access to the Support platform and obtain update and other services from Autel, you are required to register the MaxiCOM Diagnostic Device the first time you use it.

➤ To register the diagnostic device

1. Visit the website: <http://pro.autel.com> on a personal computer.
2. On the Sign In page, input your account ID and password.
3. If you are a new Autel product user and do not have an account yet, click the **Create Autel ID** button on the left side.
4. Enter the required information in the input fields, read through Autel's Terms and Conditions and check **Agree**, and then click **Create Autel ID** to continue.
5. A confirmation email will be sent to the registered email address. Validate your account by clicking on the link provided. A product registration screen displays.
6. The device's serial number and password are located on the About screen under Settings on the tablet.
7. Select the product model of your device, enter the product serial number and password on the Product Registration screen, and click **Submit** to complete the registration.

Support Screen Layout

The Support application screen is navigated with four simple buttons on the top navigation bar, operation of each is described below in turn from left to right:

- **Home Button** – returns to the MaxiCOM Job Menu.
- **Back** – press to return to the previous screen.
- **Forward** – press to advance one screen at a time until the last screen visited is displayed.
- **Refresh** – reload and update the screen.



Figure 10-1 Sample Support Application Screen

The main section of the Support screen is divided into two sections. The narrow column on the left is the main menu; select a heading from the main menu to its corresponding functions on the right.

My Account

The My Account screen displays the comprehensive information of the user and the product including the user, device, update and service information, synchronized with the registered account.

Personal Info

The User Info and Device Info are both included under the Personal Info section.

- **User Info** – displays detailed information of your registered on-line Autel account, such as your Autel ID, Name, Address and other contact information.
- **Device Info** – displays the registered product information, including the Serial Number, Registration Date, Expire Date, and Warranty Period.

Update Info

The Update Info section displays a detailed record of the product's software update history, including the product serial number, software version or name, and the update time.

Service Info

The Service Info section displays a detailed record of the device's service history information. The device's service history including completed service repairs and software re-installations will be recorded and synchronized with the associated account.

User Complaint

The User Complaint screen allows you to initiate a complaint case, as well as view historical complaint records.

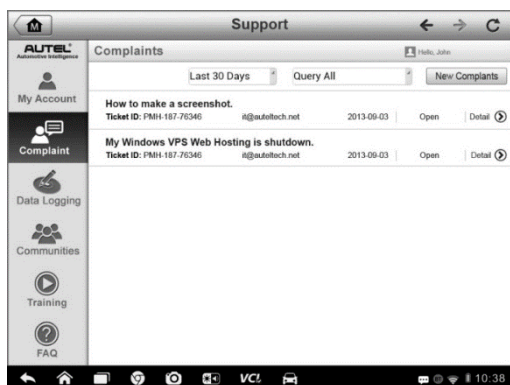

Figure 10-2 Sample Complaint Screen

The User Complaint screen consists of two parts.

1. Option Bar

- **Period Filter** – displays only the complaint records within the defined period.
- **Status Filter** – displays the corresponding complaint records according to the selected case status.
- **New Complaint Button** – starts a new complaint case.



2. Complaint List

The complaint list normally displays all the complaint records of all time and all status by default. The summary information for each complaint item includes the Subject Name, Ticket ID, User's Account ID, Date, and the Case Status.

There are four kinds of the case status:

- **Open** – indicates the complaint case has been started but not processed yet
- **Suspended** – indicates the complaint case is being processed
- **Waiting Customer Reply** – indicates the complaint has been replied by the service personnel, and requires feedback from the customer
- **Closed** – indicates the complaint case has been processed, solved,

and ended

- To view the detailed complaint session, tap the  button on the right side of the case item.
- **To establish a new complaint session**
 1. Register the product online.
 2. Tap the **Support** application on the MaxiCOM Job Menu. The device information is automatically synchronized with the online account.
 3. Tap **Complaint** on the Main Menu.
 4. Tap the **New Complaint** button at the upper right corner. A selection menu with a category of service channels displays.
 5. Select your target service channel and click **Next** to continue. A standard complaint form displays, on which you are allowed to enter detailed information, such as personal information, vehicle information, and device information. PDFs and image files can also be attached to the form.
 6. In order to settle the complaint more efficiently, it is recommended to fill out the complaint form as detailed as possible.
 7. Select the required processing time on the last section according to the urgency of the case.
 8. Tap **Submit** to send the completed form to Autel's online service center, or tap **Reset** to refill it. The submitted complaints will be processed and responded to by customer service personnel.
- **To make a reply in a complaint session**
 1. Register the product online.
 2. Tap the **Support** application on the MaxiCOM Job Menu. The device information is automatically synchronized with the online account.
 3. Tap **Complaint** on the Main Menu.
 4. Select an existing complaint case item on the record list by tapping the  button on its right side. The screen displays the complaint session details.
 5. To reply, tap the **Post Reply** button on the upper right side.
 6. Input the content in the input field, and if necessary, upload an

attaching file.

7. Tap **Submit** to post the reply.
8. Tap the **States** selection drop-down menu to reset a case state.
9. Tap the **Update** button to commit the newest update.

Data Logging

The Data Logging section keeps records of all sent or unsent (saved) data loggings on the diagnostic system. The support personnel receive and process the submitted reports through the Support platform. Support personnel will reply to the submitted issue and corresponding Data Log session within 48 hours.



Figure 10-3 Sample Data Logging Screen

➤ To make a reply in a Data Logging session

1. Tap on the **Sent** tag to view a list of submitted data logs.
2. Select a specific item to view the latest update of the submitted issue.
3. Tap on the input field at the bottom of the screen and enter text. Tap the Audio button to record a voice message, or tap camera button to take a picture.
4. Tap **Send** to send your message to the technical center.

Communities

The Communities section launches and synchronizes with the Technical Forums on Autel's official website www.autel.com. The community's forum

allows for discussion of technical issues, the sharing of information or tips with other members in Autel's online support communities.

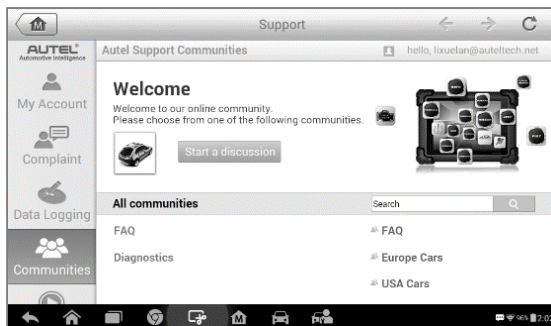



Figure 10-4 Sample Communities Home Screen

- **To start a discussion**
 1. Tap **Start a discussion** on the Communities Home screen. A list of the major forums is displayed.
 2. Select a desired community according to the subject you are interested in.
 3. Enter your topic and the discussion content in the appropriate input field.
 4. Select a category or edit tags for the discussed post. This will help other members with similar interest to find your post.
 5. Tap **OK** to submit the post.
- **To join and reply to a discussion post**
 1. Select a forum group either by product or feature on the Communities Home screen. A list of the latest posts is displayed.
 2. Select a specific category on the Categories menu to better pinpoint the topics you are most interested in.
 3. Tap the  button on the right side of the topic item to view the discussion. The posts displays.
 4. Browse through all the posts by sliding the screen up and down. Tap **Go to original post** to return to the first post.
 5. Tap **Reply** to reply to a specific post, or tap **Reply to original post** to join and continue the whole discussion.

6. Enter your comment in the input field, and tap **OK** to submit your post.

User Profile

The User Profile section allows you to set personal Avatar, check your member status and review your posts to the communities.

Tap the Avatar image on the Communities screen to open the User Profile.



Figure 10-5 Sample User Profile Screen

- **Profile** – displays the user’s personal information and member status. The **Related links** allow you to check the Top Users (ranked according to their points and levels) in the communities, as well as to find out about other online users.
- **Avatar** – allows you to select an image to set as an Avatar to be displayed in the communities.
- **Stuff** – displays a list of your posts in the various forums.

Training Channels

The Training section provides quick links to Autel’s online video accounts. Select a video channel by language to see all the available online tutorial videos.

FAQ Database

The FAQ section provides comprehensive answers to the most frequently asked questions about member accounts and online subscription purchases.

- **Account** – displays questions and answers about the use of Autel's online user account.
- **Shopping & Payment** – displays questions and answers about online subscription purchase, payment methods or procedures.

11 Academy

Autel provides various tutorials and technical bulletins written by top-notch technicians and product experts. Please review the materials on the tablet or view additional technical articles on the online forum by clicking on click on the links provided.

12 Remote Desk

The Remote Desk application launches the TeamViewer Quick Support program, a simple, fast and secure remote control screen. Use this application to receive ad-hoc remote support from Autel's support technicians by allowing them to control your MaxiCOM tablet on their PC via the TeamViewer software.

Make sure the tablet is connected to the Internet before launching the Remote Desk application.

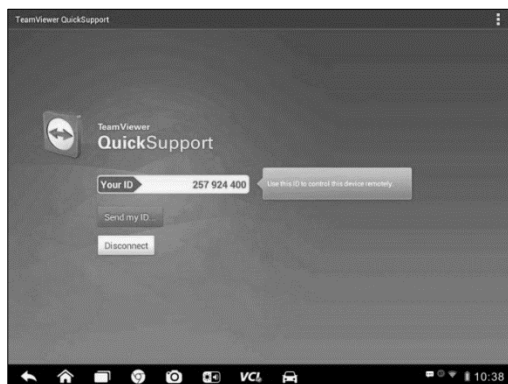

Figure 12-1 Sample Remote Desk Screen

- **To receive remote support from a partner**
 1. Power on the tablet.
 2. Tap the **Remote Desk** application on the MaxiCOM Job Menu. The TeamViewer screen displays and the device ID is generated and shown.
 3. Your partner must install the Remote Control software to his/her computer by downloading the TeamViewer full version program online (<http://www.teamviewer.com>), and then start the software on

his/her computer at the same time, in order to provide support and take control of the Display Tablet remotely.

4. Provide your ID to the partner, and wait for him/her to send you a remote control request.
5. A popup will display to ask for your confirmation to allow remote control on your device.
6. Tap **Allow** to accept, or tap **Deny** to reject.

Refer to the associated TeamViewer documents for additional information.

13 MaxiFix

The MaxiFix application launches the on-line troubleshooter database, which not only provides you virtually all common diagnostic trouble code (DTC) database for most vehicles, but also serves as a forum allowing for technicians to network with other MaxiCOM users, and gives you access to a vast database of repair and diagnostic tips along with proven filed fixes.

While the MaxiFix database keeps growing with daily troubleshooting resources and the advisory reports from MaxiCOM users from all over the world.

Information in the MaxiFix database is organized into a series of diagnostic tips that are designed to quickly lead to the root cause of a particular problem on the test vehicle.

Navigation

You need to register the device to your online account before launching the MaxiFix platform, see [Product Registration](#) on page 91 for details.



Figure 13-1 Sample MaxiFix Home Page

The MaxiFix screen layout consists of 3 main areas:

1. **The Header** – the tool bar across the top of the screen which allows you to select vehicles and perform searches.
2. **The Main Screen** – located at the center of the screen displaying content based on the vehicle attributes and keywords specified. The tabs on the main screen vary in accordance with the section selected on the Navigation Menu, allowing you to switch between functions.
3. **The Navigation Menu** – the main menu at the bottom of the screen that provides you access to different sections of MaxiFix.

The Header

The Header at the top of the screen features:

- A Select Vehicle button to open the vehicle identification window, and vehicle information bar, for example “2014 > Hyundai > Accord Coupe > L4-2.4L (K24W1)”.
- A search field to find relevant information by entering keywords, codes, or problems.

Select Vehicle Button

The “Select Vehicle” button on the Header allows you to specify the vehicle which you want to research on MaxiFix, by selecting each of the vehicle attribute from a sequence of option lists. This feature helps to filter out the searches that allow only the information that applies to the identified vehicle to display.

NOTE

All attributes must be specified to make a complete vehicle selection for the most efficient search.

➤ To select a vehicle

Follow the procedure below to select a vehicle:

1. If you haven't already done so, click the “Select Vehicle” button on the Header.
2. Select the **year** of the vehicle from the list.
3. Select the **make** of the vehicle from the list.
4. Select the **model** of the vehicle from the list.

5. Select the **submodel** of the vehicle from the list.
6. Select the **engine** of the vehicle from the list.

After completing the vehicle selection procedure, the identified vehicle is shown on the Header.

Terminology

MaxiFix Tip

A MaxiFix Tip offers a detailed outline of an actual vehicle repair. Combined with proven results and vehicle specific data, this all-in-one information source provides quick and easy repair solutions.

On MaxiFix community you can find Tips or share your own Tip with the community.

➤ **To search for a MaxiFix Tip**

1. Select a Vehicle:
 - a) Click the "Select Vehicle" button on the Header at the top of the page.
 - b) Select the **year** of the vehicle from the list.
 - c) Select the **make** of the vehicle from the list.
 - d) Select the **model** of the vehicle from the list.
 - e) Select the **submodel** of the vehicle from the list.
 - f) Select the **engine** of the vehicle from the list.

After completing the vehicle selection, the chosen vehicle is shown in the Header.

2. Enter a Search Term.

MaxiFix has an exclusive one-stop lookup that helps you find all of MaxiFix resources with one click. Simply enter a search term into the search bar on the Header to begin the search.

3. Proven Results!

The powerful MaxiFix database gives you proven results. The typical MaxiFix Tips combine actual workshop fixes and vehicle repair data that may include:

- a) OBD II Fault Codes description and reference – helps in diagnostic assessment by making clear the nature of an automotive problem so that beginner and advanced technicians can make effective repairs.
- b) Real Fix Tips – provides repair tips from actual shop practices and are presented in an easy to understand Complaint, Cause, Correction format.

If you are unable to find the information relating to your specific problem, you can pose a question to the MaxiFix community by clicking “Ask” on the Navigation Menu at the bottom of the screen.

Adopted!

The “Adopted!” icon displays at the top right side of a Tip page when at least one technician has “adopted” or recommended the tip. If a tip has helped you to solve a repair problem, you are encouraged to give an Adopted! count to the tip. Each member is allowed to click the “Adopted!”. The “Adopted!” count helps you to easily identify which tips that are really helpful. You can also post a comment about how the tip has helped you as reference to other members.

Operations

The Navigation Menu is at the bottom of the screen. Selecting the items on the Navigation Menu allows you to switch between the main sections on MaxiFix. These main sections include:

- **Home** – shows all questions and allows you to specify questions about one or multiple makes.
- **Search Fix** – allows you to search for information from all available resources on MaxiFix, including: Open Questions, Tips, and Real Fixes, and displays search results.
- **Ask** – allows you to ask a question in the community.
- **My MaxiFix** – displays all your posts including Questions and Fixes in the community, and allows you to view your personal profile, select your vehicle preference, and share your tips.
- **My Messages** – shows a list of message notifications that are relevant to your activities in the Question section.
- **Support** – opens the FAQ page, or a message box for contacting Customer Service by email.

Home

Home is the first option on the Navigation Menu at the bottom of the screen. Tap to open your MaxiFix home page. There is a list of questions posted on the community, and you can scroll down the page to the bottom and view more questions by tapping “View More”. Click on any question and you will be directed to the detailed page in the Ask section.

Click the “Filter” button on the main page of Home, and select the vehicle manufacturers that you are interested in. This filter can be canceled anytime by clicking the “Remove All Filters” button, and the default setting will be restored to display questions about all vehicle makes.

Search Fix

Search Fix, the second option on the Navigation Menu at the bottom of the screen, presents search results for the specified vehicle. Search results are listed in various categories:

- **All** – includes all search results, including related Questions, Tips, and Real Fixes to your search.
- **Questions** – presents a list of open Question discussed in the community that may be pertinent to your search.
- **Tips** – presents a list of Tips that directly correlate to your search criteria. Select a Tip from the list to open and review the complete Tip.
- **Real Fixes** – presents a list of Tips that have been collected from actual shop repair orders and are presented in an easy-to-understand Complaint, Cause, and Correction format.

Ask

Ask, the third option on the Navigation Menu at the bottom of the screen, allows you to ask a question about a particular vehicle repair issue in the community.

➤ To ask a MaxiFix Question

1. Click **Select Vehicle** on the Header to specify the vehicle you are asking about.
2. Click **Ask** on the Navigation Menu at the bottom of the screen to open

the Ask page.

3. On the **Ask** page find **Ask for Help** and complete the section to ask a question.

The Ask page has 4 sections:

- **Subject** – enter a brief subject for the question.
- **My Question** – ask a clear and concise question that you want to ask the community. Be sure to be descriptive and concise when asking your question.
- **Problem Description** – describe how the vehicle is behaving.
- **Repair History** – include any previous diagnostic tests that you performed, including the results of the tests. Also list any parts that were replaced during previous diagnostic work.

Tap the “Cancel” button to cancel your question and return to the Ask page.

Tap the “Submit” button to post your question to the community.

Tap the “Attach File” button to include images or reference files with your question.

Select one answer from the responses and then close the question. For details, please refer to My Messages section.

My MaxiFix

My MaxiFix, the fourth option on the Navigation Menu at the bottom of the screen, opens your personal MaxiFix page. To access the features on My MaxiFix page you can select from the following tabs:

- **My Questions** – opens a list with links to the opened questions that you have posted to the community.
- **My Cases** – opens a list with links to the closed questions and tips that you have contributed to the community.
- **Marked Posts** – opens a list with links to Tips and discussions that you are actively participating in.
- **My Profile** – allows you to view your Autel account information including: your Autel ID, personal information, MaxiFix score, phone number and register time, and add an avatar image.

- **Vehicle Preference** – used to set up a list of preferred vehicles. The preferred list allows you to limit the choices that display on the “Select Vehicle” list to specific years, and makes. Click “Set Year” or “Set Make” to set your preferred models. The preferred makes will also be displayed in the “Filter” options on the Home page.
- **Share a Tip** – allows you to share your personal repair experience with the community.

Click **My MaxiFix** on the Navigation Menu at the bottom of the screen, to display all questions and tips that you have contributed to the community.

Create a Tip

A “Tip” is a concise and complete description of the fix for a particular vehicle repair issue.

➤ **To create a new MaxiFix Tip**

1. Select **My MaxiFix** from the Navigation Menu.
2. Select **Select Vehicle** from the Header and enter the identifying attributes of the vehicle you are writing the Tip about.
3. On the My MaxiFix page find **Share a Tip**; click this link to open the **My Tips** page.
4. Enter the Tip subject in the **Subject** field.
5. Compose your Tip in the **Description** field. Include as much information as possible, while keeping the information concise and to the point. A Tip should provide accurate information that is reader-friendly.

Use the **Cancel** button at the right-side bottom of the page to cancel a tip and return to the My MaxiFix page.

Or use the **Submit** button at the right-side bottom of the page to add your tip to the community.

Use the **Attach File** button at the left-side bottom of the page to include images or other supporting data with your question.

View Profile Information

You can view or edit your personal profile by clicking on your account ID or “My Profile” in My MaxiFix section. View the profiles of other community

members' profile by clicking their portrait. Information included in your profile determines how you are presented to the community, and what type of information will be sent to you from the community.

My Messages

My Messages, the fifth option on the Navigation Menu at the bottom of the screen, shows a list of message notification that are relevant to your activities in the Question section. A notification icon will appear on the top-right corner of "My Messages" if there is any new or unread message in the Question section. The number on the notification icon indicates the total number of the new and unread messages. The message notification will appear under the following two conditions:

1. A MaxiFix community member has replied to Your question or answer.
2. A MaxiFix community member has "Adopted!" one of your answers.

Tap **My Messages**, select and open a message from the list. If your problem is solved according to the reply, you should select one Adopted Answer and close the question. If your answer is marked as "Adopted!", "Adopted! + 4" will be displayed permanently.

Tap **Clear** to delete all message notifications.

Select "Adopted Answers"

Members should select one Adopted Answer from responses on the "My Messages" page before closing a question. Community members who provided the Adopted Answer are rewarded with scores for their contribution.

About Adopted Answer:

- Only one answer can be selected as "Adopted Answer".
- Only the MaxiFix member who asked the questions can rate the "Answer".

Close a Question

When a repair question that you've posted to the community is resolved, you are encouraged to write down the case as a way to share a good information within the community. This will help the other MaxiFix members.

To close a question, you need to select the question's response message from the message list on "My Messages" page first, then tap "Adopted Answer" and select "Close Question". Tap the "Cancel" button to cancel your submission and return to My Messages page. It is strongly recommended that you share your repair solutions before closing a question. Your question will be converted to a MaxiFix Community Tip after closing.

Score Rewarding System

1. A score of 4 is awarded if your answer is selected as the "Adopted Answer".
2. A score of 3 is awarded when you close a question.
3. A score of 2 is awarded if your closed question is marked as "Adopted!" by no less than 20 community members.
4. A score of 1 is awarded if your answer is selected as the "Adopted Answer" for a closed question that is marked as "Adopted!" by no less than 20 community members.
5. A score of 1 is awarded to each of the first three respondents.

Support

Support, the last option on the Navigation Menu at the bottom of the screen, opens a page that provides two ways to gain support from MaxiFix:

1. A message form to contact the MaxiFix administrator.
2. Frequently Asked Questions (FAQ) section that answers the community's most frequently asked questions.

If you wish to contact the administrator of this site please use the contact form. Select "Support" from the Navigation Menu to open the comment window. To allow the administrator to respond to your question or issue, the following information should be provided:

- Your name
- A contact email address
- A contact phone number

14 Quick Link

The Quick Link application provides access to Autel's official website and to other popular automotive service websites. These sites are invaluable resources of automotive information and repair data and include forums, video training and expert consultation.

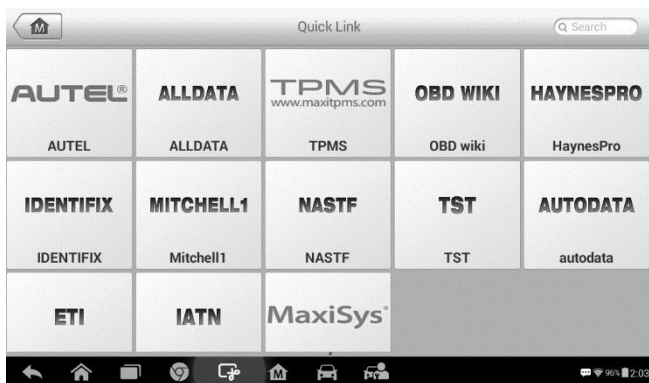

Figure 14-1 Sample Quick Link Screen

➤ **To open a quick link**

1. Tap the **Quick Link** application on the MaxiCOM Job Menu. The Quick Link application screen displays.
2. Select a website thumbnail from the main section. The Chrome browser is launched and the selected website is opened.
3. Now you can start exploring the website!

Function	Sub function	Version
Specil Function	Audio System Test	Above Fiat_V5.00
Specil Function	Bleed Hydraulic Circuit	Above Fiat_V5.00
Specil Function	Brake Switch Learn	Above Fiat_V5.00
Specil Function	CTM Proxi Configuration	Above Fiat_V5.00
Specil Function	Check PCM Odometer	Above Fiat_V5.00
Specil Function	Check PCM VIN	Above Fiat_V5.00

Figure 15-2 Sample Function Viewer Screen 2

➤ **To search by the functions**

1. Tap the **Function Viewer** application on the MaxiCOM Job Menu. The Function Viewer application screen displays.
2. Tap the tool name on the top left to drop down the tool list, tap the one you want to search.
3. Type in the function you want to search to the top right search column. All the vehicles with this function will be listed with 8 columns, the Brand, Model, Year, System, Sub system, Function, Sub function, and Version.

 **NOTE**

Fuzzy search is supported, type in part of the function you want to search for.

Cancel functions 🔍 Reset ECM

MaxiSys ▲ Brand/Model/Year ▲

Brand	Model	Year	System	Sub system	Function	Sub function	Version
Buick	Others	(6) 2006	Powertrain	/	Special Function	Reset ECM	Above GM_V9.50
Buick	Others	(8) 2008	Engine control module	/	Special Function	Reset ECM	Above GM_V9.50
Chevrolet	Aveo	(4) 2004	Powertrain	/	Special Function	Reset ECM	Above GM_V9.50
Chevrolet	Aveo	(5) 2005	Powertrain	/	Special Function	Reset ECM	Above GM_V9.50
Chevrolet	Aveo	(6) 2006	Powertrain	/	Special Function	Reset ECM	Above GM_V9.50
Chevrolet	Aveo	(7) 2007	Engine control module	/	Special Function	Reset ECM	Above GM_V9.50
			Engine control		Special		Above

⏪ 🏠 📁 📍 🚗 🚚 📶 8:24

Figure 15-3 Sample Function Viewer Screen 3

16 Maintenance and Service

Maintenance Instructions

The following shows how to maintain your devices, together with precautions to take.

- Use a soft cloth and alcohol or a mild window cleaner to clean the touch screen on the tablet.
- Do not use any abrasive cleansers, detergent, or automotive chemicals to the tablet.
- Only use the device in dry conditions within normal operating temperatures.
- Dry your hands before using the tablet. The touch screen of the tablet may not work if the touch screen is moist, or if you tap the touch screen with wet hands.
- Do not store the devices in humid, dusty or dirty areas.
- Before and after use, check the housing, wiring, and connectors for dirt and damage before and after each use.
- At the end of each work day, wipe the device housing, wiring, and connectors clean with a damp cloth.
- Do not attempt to disassemble your tablet or the VCI unit.
- Take care not drop the device or allow anything heavy to drop on the device.
- Use only authorized battery chargers and accessories. Any malfunction or damage caused by the use of unauthorized battery charger and accessories will void the limited product warranty.
- Ensure that the battery charger does not come in contact with conductive objects.
- Do not operate the tablet next to anything such as microwave oven, cordless phones and some medical or scientific instruments that might interfere with or prevent signal interference.

Troubleshooting Checklist

A. When the Display Tablet does not work properly:

- Make sure the tablet has been registered online.
- Make sure the system software and diagnostic application software are properly updated.
- Make sure the tablet is connected to the Internet.
- Check all cables, connections, and indicators to see if the signal is being received.

B. When battery life is shorter than usual:

- This may happen when you are in an area with low signal strength. Turn off your device when not in use.

C. When you cannot turn on the tablet:

- Make sure the tablet is connected to a power source or the battery is charged.

D. When you are unable to charge the tablet:

- Your charger maybe out of order. Contact your nearest dealer.
- You may be attempting to use the device in an overly hot/cold temperature. Try changing the charging environment.
- Your device may have not been connected to the charger properly. Check the connector.

NOTE

If your problems persist, please contact Autel's technical support personnel or your local selling agent.

About Battery Usage

Your tablet is powered by a built-in Lithium-ion Polymer battery. This means that, unlike other forms of battery technology, you can recharge your battery while some charge remains without reducing your tablet's autonomy due to the "battery memory effect" inherent in those technologies.

 **DANGER**

The built-in Lithium-ion Polymer battery is factory replaceable only; incorrect replacement or tampering with the battery pack may cause an explosion. Do not use a damaged battery charger.

- Do not disassemble or open crush, bend or deform, puncture or shred.
- Do not modify or remanufacture, attempt to insert foreign objects into the battery, expose to fire, explosion or other hazard.
- Make sure to use the charger and USB cables only that come together in the package. If you use the other charger and USB cables, you might incur malfunction or failure of the device.
- Only use the charging device that has been qualified with device per the standard. Use of an unqualified battery or charger may present a risk of fire, explosion, leakage, or other hazard.
- Avoid dropping the tablet. If the tablet is dropped, especially on a hard surface, and the user suspects damage, take it to a service center for inspection.
- The closer you are to your network's base station, the longer your tablet usage time because less battery power is consumed for the connection.
- The battery recharging time varies depending on the remaining battery capacity.
- Battery life inevitably shortens over time.
- Since over charging may shorten battery life, remove the tablet from its charger once it is fully charged. Unplug the charger, once charging is complete.
- Leaving the tablet in hot or cold places, especially inside a car in summer or winter, may reduce the capacity and life of the battery. Always keep the battery within normal temperatures.

Service Procedures

This section introduces information for technical support, repair service, and application for replacement or optional parts.

Technical Support

If you have any question or problem on the operation of the product, please contact us (see the following contact info) or your local distributor.

AUTEL NORTH AMERICA

- **Phone:** 1-855-AUTEL-US(288-3587) Monday-Friday 9am-6pm EST
- **Website:** www.autel.com
- **Email:** sales@autel.com; ussupport@autel.com
- **Address:** 175 Central Avenue, Suite 200, Farmingdale, New York, USA 11735

AUTEL EUROPE

- **Phone:** 0049 (0) 6103-2000520
- **Website:** www.autel.eu
- **Email:** sales.eu@autel.com; support.eu@autel.com
- **Address:** Adalperostraße 82, 85737 Ismaning, Germany

AUTEL CHINA HQ

- **Phone:** 0086-755-2267-2493
- **Website:** www.autel.com
- **Email:** sales@auteltech.net; support@autel.com
- **Address:** 7-8th, 10th Floor, Building B1, Zhiyuan, Xueyuan Road, Xili, Nanshan, Shenzhen, 518055, China

AUTEL LATIN AMERICA

- **Website:** www.autel.com
- **Email:** sales.latin@autel.com; latsupport02@autel.com
- **Address:** Avenida Americas 1905, 6B, Colonia Aldrete, Guadalajara, Jalisco, Mexico

AUTEL APAC

- **Phone:** +045 5948465
- **Website:** www.autel.com/jp/

- **Email:** sales.jp@autel.com; support.jp@autel.com
- **Address:** 719, Nissou Building, 3-7-18, Shinyokohama, Kouhoku, Yokohama, Kanagawa, Japan 222-0033

AUTEL IMEA DMCC

- **Phone:** +971 585002709
- **Website:** www.autel.com
- **Email:** sales.imea@autel.com; imea-support@autel.com
- **Address:** Office 1006-1010, Cluster C, Fortune Tower, Jumeirah Lakes Tower (JLT), Dubai, U.A.E

Repair Service

If it becomes necessary to return your device for repair, please download the repair service form from www.autel.com, and fill it in. The following information must be included:

- Contact name
- Return address
- Telephone number
- Product name
- Complete description of the problem
- Proof-of-purchase for warranty repairs
- Preferred method of payment for non-warranty repairs

NOTE

For non-warranty repairs, payment can be made with Visa, Master Card, or with approved credit terms.

Send the device to your local agent, or to the below address:

8th Floor, Building B1, Zhiyuan,
Xueyuan Road, Xili, Nanshan,
Shenzhen, 518055, China

Other Services

You can purchase the optional accessories directly from Autel's authorized tool suppliers, and/or your local distributor or agent.

Your purchase order should include the following information:

- Contact information
- Product or part name
- Item description
- Purchase quantity

17 Compliance Information

FCC Compliance

FCC ID: WQ8-1610MX808

This device complies with Part 15 of the FCC rules and Industry Canada's license-exempt RSSs. Operation is subject to the following two conditions:

1. This device may not cause harmful interference.
2. This device must accept any interference received, including interference that may cause undesired operation.

Cet appareil est conforme aux CNR exempts de licence d'Industrie Canada. Son fonctionnement est soumis aux deux conditions suivantes:

1. Ce dispositif ne peut causer des interférences; et
2. Ce dispositif doit accepter toute interférence, y compris les interférences qui peuvent causer un mauvais fonctionnement de l'appareil.

WARNING

Changes or modifications not expressly approved by the party responsible for compliance could void the user's authority to operate the equipment.

NOTE

This equipment has been tested and found to comply with the limits for a Class B digital device, pursuant to Part 15 of the FCC Rules. These limits are designed to provide reasonable protection against harmful interference in a residential installation.

This equipment generates uses and can radiate radio frequency energy and, if not installed and used in accordance with the instructions, may cause harmful interference to radio communications. However, there is no guarantee that interference will not occur in a particular installation. If this equipment does cause harmful interference to radio or television reception, which can be determined by turning the equipment off and on, the user is encouraged to try to correct the interference by one or more of the following measures:

- Reorient or relocate the receiving antenna.

- Increase the separation between the equipment and receiver.
- Connect the equipment into an outlet on a circuit different from that to which the receiver is connected.
- Consult the dealer or an experienced radio/TV technician for help.

Changes or modifications not expressly approved by the party responsible for compliance could void the user's authority to operate the equipment.

SAR

The radiated output power of this device is below the FCC radio frequency exposure limits. Nevertheless, the device should be used in such a manner that the potential for human contact is minimized during normal operation.

The exposure standard for wireless devices employs a unit of measurement known as the Specific Absorption Rate, or SAR. The SAR limit set by the FCC is 1.6 W/Kg. Tests for SAR are conducted using standard operating positions accepted by the FCC with the device transmitting at its highest certified power level in all tested frequency bands.

Although the SAR is determined at the highest certified power level, the actual SAR level of the device while operating can be well below the maximum value. This is because the device is designed to operate at multiple power levels so as to use only the power required to reach the network. To avoid the possibility of exceeding the FCC radio frequency exposure limits, human proximity to antenna should be minimized.

RF WARNING STATEMENT

The device has been evaluated to meet general RF exposure requirement. The device can be used in portable exposure condition without restriction.

The term "IC" before the radio certification number only signifies that IC technical specifications were met.

RoHS COMPLIANCE

This device is declared to be in compliance with the European RoHS Directive 2011/65/EU.

CE COMPLIANCE

This product is declared to conform to the essential requirements of the following Directives and carries the CE mark accordingly:

EMC Directive 2014/30/EU

R&TTE Directive 1999/5/EC

Low Voltage Directive 2014/35/EU

18 Warranty

Limited One Year Warranty

Autel Intelligent Technology Corp., Ltd. (the Company) warrants to the original retail purchaser of this MaxiCOM Diagnostic Device, that should this product or any part thereof during normal consumer usage and conditions, be proven defective in material or workmanship that results in product failure within one (1) year period from the date of purchase, such defect(s) will be repaired, or replaced (with new or rebuilt parts) with Proof of Purchase, at the Company's option, without charge for parts or labor directly related to the defect(s).

The Company shall not be liable for any incidental or consequential damages arising from the use, misuse, or mounting of the device. Some states do not allow limitation on how long an implied warranty lasts, so the above limitations may not apply to you.

This warranty does not apply to:

- a) Products subjected to abnormal use or conditions, accident, mishandling, neglect, unauthorized alteration, misuse, improper installation or repair or improper storage;
- b) Products whose mechanical serial number or electronic serial number has been removed, altered or defaced;
- c) Damage from exposure to excessive temperatures or extreme environmental conditions;
- d) Damage resulting from connection to, or use of any accessory or other product not approved or authorized by the Company;
- e) Defects in appearance, cosmetic, decorative or structural items such as framing and non-operative parts.
- f) Products damaged from external causes such as fire, dirt, sand, battery leakage, blown fuse, theft or improper usage of any electrical source.

! **IMPORTANT**

All contents of the product may be deleted during the process of repair. You should create a back-up copy of any contents of your product before delivering the product for warranty service.
